

USER MANUAL

14.2 cu.ft. Top Freezer Refrigerator

ERT14CSCW

ERT14CSCB

ERT14CSCS

Product may vary. Refer to the actual product

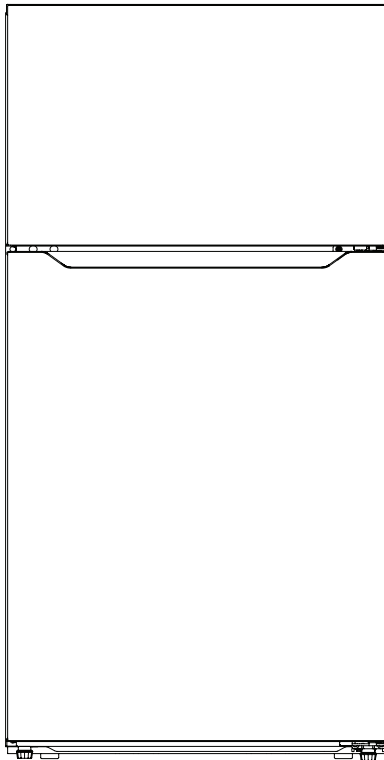

CONTENTS

1.SAFETY INFORMATION	3
2.PROPER USE OF REFRIGERATOR.....	11
2.1 PLACEMENT.....	11
2.2 ENERGY SAVING TIPS	12
2.3 CHANGING THE LIGHT.....	12
2.4 START TO USE.....	13
2.5 COMPONENTS.....	14
2.6 FUNCTIONS	16
2.7 REVERSE DOOR HINGES (OPTIONAL).....	17
2.8 LEVELING FEET	20
3.MAINTENANCE OF REFRIGERATOR.....	21
3.1 OVERALL CLEANING.....	21
3.2 DEFROSTING.....	22
3.3 OUT OF OPERATION	22
4.TROUBLESHOOTING.....	23
5.APPENDIX	24
6.WARRANTY.....	28

1. SAFETY INFORMATION

YOUR SAFETY AND THE SAFETY OF OTHERS ARE VERY IMPORTANT

To prevent injury to the user or other persons and property damage, these instructions must be followed. Incorrect operation due to ignoring instructions may cause harm or damage, leading to serious injuries or death.

The level of risk is shown by the following indications.



Prohibition symbol

This is a prohibition symbol.

Any in compliance with instructions marked with this symbol may result in damage to the product or endanger the personal safety of the user.



Warning symbol

This is a warning symbol.

It is required to operate in strict observance of instructions marked with this symbol; otherwise damage to the product or personal injury may be caused.



Cautioning symbol

This is a cautioning symbol.

Instructions marked with this symbol require special caution. Insufficient caution may result in slight or moderate injury or damage to the product.

IMPORTANT SAFETY INSTRUCTIONS



Risk of fire / Flammable materials



WARNING

- This appliance is intended to be used in households and similar locations such as staff kitchen areas in shops, offices and other working environments; farmhouses and by clients in hotels, motels and other residential type environments; bed and breakfast environments; catering and similar non-retail locations.
- This appliance is not intended for use by persons (including children) with reduced physical, sensory or mental capabilities, or lack of experience and knowledge, unless they have been given supervision or instruction concerning use of the appliance by a person responsible for their safety.

- Children should be supervised to ensure that they do not play with the appliance.
- If the supply cord is damaged, it must be replaced by the manufacturer, service agent, or another qualified persons in order to avoid a hazard.
- Do not store explosive substances such as aerosol cans with a flammable propellant in this appliance.
- The appliance must be unplugged after use and before carrying out user maintenance.
- **WARNING:** Keep ventilation openings in the appliance enclosure or in the built-in structure clear of obstructions.
- **WARNING:** Do not use mechanical devices or other means to accelerate the defrosting process, other than those recommended by the manufacturer.
- **WARNING:** Do not damage the refrigerant circuit.
- **WARNING:** Do not use electrical appliances inside the food storage compartments of the appliance, unless they are recommended by the manufacturer.
- **WARNING:** Dispose of the refrigerator according to local regulations since it uses flammable blowing gas and refrigerant.
- **WARNING:** When positioning the appliance, ensure the supply cord is not trapped or damaged.
- **WARNING:** Do not place multiple portable socket-outlets or portable power supplies at the rear of the appliance.
- **WARNING:** Do not use extension cords or ungrounded (two prong) adapters.
- **WARNING:** To avoid a hazard due to instability of the appliance, it must be fixed in accordance with the instructions.
- **WARNING:** Risk of child entrapment. Before you dispose of your old refrigerator:
 - Take off the doors.
 - Leave the shelves in place so that children may not easily climb inside.







DANGER

- The refrigerator must be disconnected from the main power before attempting the installation of accessories.
- Refrigerant and cyclopentane foaming material used for the appliance are flammable. Therefore, when the appliance is scrapped, it should be kept away from any fire source and be recycled by a special recycling company with corresponding qualification other than be disposed by combustion, to prevent damage to the environment or any other harm.
- For doors or lids fitted with locks, the keys must be kept out of reach of children and not in the vicinity of the refrigerating appliance, in order to prevent children from being locked inside.

! WARNING

For EU standard:

- This appliance can be used by children aged from 8 years and above and persons with reduced physical, sensory or mental capabilities or lack of experience and knowledge if they have been given supervision or instruction concerning the use of the appliance in a safe way and understand the hazards involved. Children should not play with the appliance. Cleaning and user maintenance shall not be made by children without supervision. Children aged from 3 to 8 years are allowed to load and unload refrigerating appliances.
 - To avoid contamination of food, please observe the following instructions:
 - Opening the door for long periods of time can cause a significant increase of the temperature in the compartments of the appliance.
 - Clean surfaces regularly that can come in contact with food and accessible drainage systems.
 - Clean water tanks if they have not been used for 48hours. Flush the water system connected to a water supply if water has not been drawn for 5 days. (Note 1)
 - Store raw meat and fish in suitable containers in the refrigerator, so that it is not in contact with or drip onto other food.
 - Two-star  frozen-food compartments are suitable for storing pre-frozen food, and storing ice cubes. (Note 2)
 - One-star , two-star  and three-star  compartments are not suitable for freezing fresh food. (Note 3)
 - For appliances without a 4-star  compartment: this refrigerating appliance is not suitable for freezing food. (Note 4)
 - If the refrigerating appliance is left empty for long periods of time, switch off, defrost, clean, dry, and leave the door open to prevent mold from developing within the appliance.
- Notes 1, 2, 3, 4: Please confirm whether it is applicable according to your product.
- For a freestanding appliance: this refrigerating appliance is not intended to be used as a built-in appliance.
 - Any replacement or maintenance of the LED light is intended to be made by the manufacturer, service agent or another qualified person.

SAVE THESE INSTRUCTIONS

THIS APPLIANCE IS FOR HOUSEHOLD USE ONLY

State of California Proposition 65 Warnings:

 **WARNING:** Cancer and Reproductive Harm
-www.P65Warnings.ca.gov.

PROPER DISPOSAL

WARNING

Suffocation Hazard

Before you dispose of your old refrigerator:

- Remove the door or lid so that children cannot hide or get trapped inside your old appliance.
- Leave any shelves in place so that children may not easily climb inside.
- Failure to follow these instructions can result in serious injury or death.

IMPORTANT:

Flammable gas and refrigerant are used. It is the consumer's responsibility to comply with Federal and Local regulations when disposing of this product. Refrigerants must be disposed by a licensed, EPA-certified refrigerant technician in accordance with established procedures.

ELECTRICITY-RELATED WARNINGS

- Do not pull the power cord when pulling the power plug of the refrigerator. Firmly grasp the plug and pull out from the socket.
- To ensure safe use, do not damage the power cord or use the power cord when it is damaged or worn.
- Use a dedicated power socket; the power socket should not be shared with other electrical appliances.

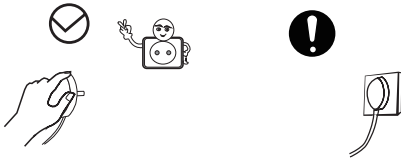

- The power cord should be firmly in the socket, otherwise a fire may be caused.
- Ensure that the grounding electrode of the power socket is equipped with a reliable grounding line.
- Turn the valve off and open the doors and windows if there is leaking gas or other flammable substances. Do not unplug the refrigerator or other electrical appliances, considering a spark may cause a fire.

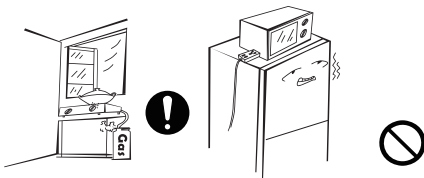

- Do not use electrical appliances on top of the appliance, unless they are recommended by the manufacturer.

WARNINGS RELATED TO PLACING ITEMS

- Do not place flammable, explosive, volatile or highly corrosive items in the refrigerator to prevent damage to the product and fire accidents.
- To avoid the risk of fire, do not place flammable items near the refrigerator.

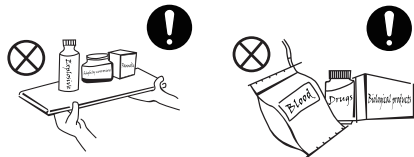

- This product is a household refrigerator and is only suitable for the storage of food. According to national standards, a household refrigerator should not be used for other purposes, such as the storage of blood, drugs or biological products.
- Do not store beer, beverages or other fluids contained in bottles or enclosed containers in the freezing chamber of the refrigerator; otherwise, the bottles or enclosed containers may crack due to freezing and cause damages.



WARNINGS FOR USE

- Do not arbitrarily disassemble or reconstruct the refrigerator, nor damage the refrigerant circuit; maintenance of the appliance must be conducted by a specialist.
- If the supply cord is damaged, it must be replaced by a manufacturer, service agent, or another qualified person in order to avoid a hazard.
- Do not allow children to enter or climb inside the refrigerator to prevent children from hiding and getting trapped in the refrigerator or being injured due to falling from the refrigerator.
- Do not spray or wash the refrigerator; do not place the refrigerator in damp places where it can be splashed with water to not affect the electrical insulation properties of the refrigerator.

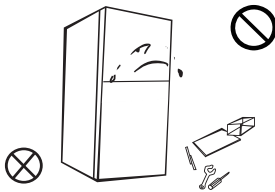

- The gaps between refrigerator door and body are small. Do not place your hands in these areas to prevent squeezing your fingers. Be careful when opening the refrigerator door to avoid objects from falling out.
- Do not pick up food or containers with wet hands in the freezing chamber when the refrigerator is running, especially metal containers in order to avoid frostbite.

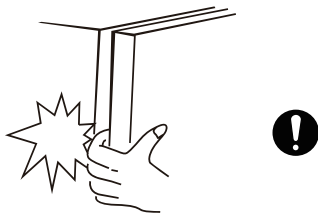

- Do not place heavy objects on top of the refrigerator considering that objects may fall when opening the door, and could cause accidental injuries.
- Pull the plug out in case of power failure or cleaning. Do not connect the refrigerator to power supply within five minutes to prevent damages to the compressor due to successive starts.

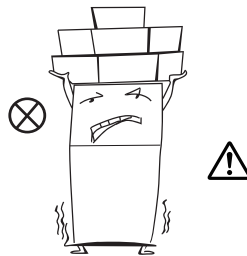

ENERGY WARNINGS

- 1.** Refrigerating appliances might not operate consistently (possibility of contents defrosting or temperature becoming too warm in the freezer compartment) when set for an extended period of time below the cold end of the temperature range for which the refrigerating appliance is designed.
- 2.** Sparkling beverages should not be stored in the freezing chamber or a lower temperature compartment. Certain drinks (such as ice water) should not be consumed too cold.
- 3.** Do not exceed the storage time(s) recommended by the food manufacturers for any kind of food; particularly for commercially quick-frozen food in food-freezer and frozen-food storage compartments or cabinets.
- 4.** Prevent an undue rise in temperature of frozen food while defrosting the refrigerating appliance, such as wrapping the frozen food in several layers of newspaper.
- 5.** A rise in temperature of frozen food during manual defrosting, maintenance or cleaning can shorten the storage life.

DISPOSAL



Refrigerant and cyclopentane foaming material used for the refrigerator are flammable. Therefore, when the refrigerator is done with, it should be kept away from any fire source and be recycled by a special recycling company with corresponding qualifications other than be disposed by combustion, so as to prevent damage to the environment or any other harm.



When the refrigerator is disposed, disassemble the doors, remove gaskets of door and shelves. Place the doors and shelves in a proper place to prevent trapping children.

Correct Disposal of this product:



This marking indicates that this product should not be disposed with other household waste. To prevent possible harm to the environment or human health from uncontrolled waste disposal, recycle it responsibly to promote the sustainable reuse of material resources. To return your used device, please use the return and collection systems or contact the retailer where the product was purchased. They take this product in for environmental safe recycling.

2. PROPER USE OF REFRIGERATOR

2.1 PLACEMENT

- Before use, remove all packing materials, including bottom pads, foam pads and tapes inside of the refrigerator; tear off the protective film on the doors and the refrigerator body.

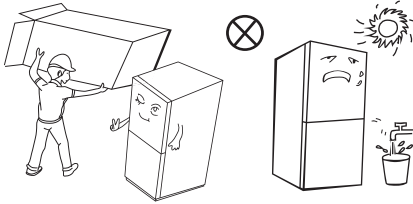

- Keep away from heat and avoid direct sunlight. Do not place the refrigerator in damp or wet places to prevent rust or reduction of the insulating effect.
- Do not spray or wash the refrigerator; do not place the refrigerator in damp places where it can be splashed with water to not affect the electrical insulation properties of the refrigerator.

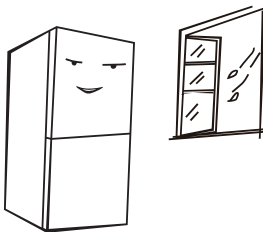

- The refrigerator is placed in a well-ventilated indoor place; the floor must be flat and sturdy (rotate left or right to adjust the wheel for leveling if unstable).

- The space on top of the refrigerator should be greater than 30cm, and the refrigerator should be placed against a wall with a distance of more than 10cm to facilitate heat dissipation.
- Spare enough space for convenient opening of doors and drawers according to the statement of the distributor.

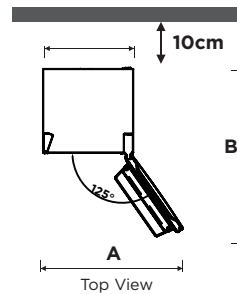
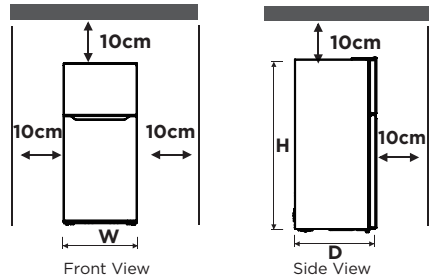

Width "W"	27.56
Depth "D"	28.78
Height "H"	60.63
A	47.72
B	51.57

(unit: inches)

The measurements in the above table may differ depending on the measuring method.

NOTE

This refrigerator needs to be installed independently and cannot be used as a built-in. Otherwise, it will cause problems such as failure to install into the cabinet, the performance and life of the product are reduced. And the manufacturer does not provide basic product warranty.

2.2 ENERGY SAVING TIPS



- The appliance should be located in the coolest area of the room, away from heat producing appliances or heating ducts, and out of direct sunlight.
- Let hot food cool down to room temperature before placing it in the appliance. Overloading the appliance forces the compressor to run longer. Food that freezes too slow may lose its quality, or spoil.
- Be sure to wrap food properly, and wipe containers dry before placing them in the appliance. This cuts down on frost build-up inside the appliance.
- Appliance storage bins should not be lined with tin foil, wax paper, or paper toweling. Liners interfere with the cold air circulation, making the appliance less efficient.
- Organize and label food to reduce door openings and extended searches. Remove as many items as needed at one time, and close the door as soon as possible.

2.3 CHANGING THE LIGHT

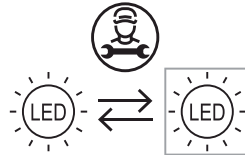
- Any replacement or maintenance of the LED lights is intended to be made by the manufacturer, service agents or another qualified person.

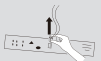

The light source in this product is only to be replaced by qualified engineers.

	1. Remove the plug.
	2. Remove the light cover with a screwdriver.
	3. Take down the light panel.
	4. Remove the connection terminal.

2.4 START TO USE

- Before initial start, keep the refrigerator still for two hours before connecting it to power supply.
- Before placing any fresh or frozen food, the refrigerator should run for 2 - 3 hours, or above 4 hours in summer when the ambient temperature is high.

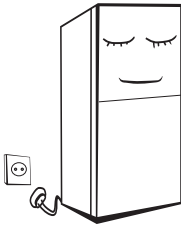

NOTE

**This product is not recommended for use with sockets or main switch with the A/GFCI function, otherwise it may cause false tripping.
If tripping persists, it is recommended to replace the sockets or main switch without A/GFCI function.**

2.5 COMPONENTS

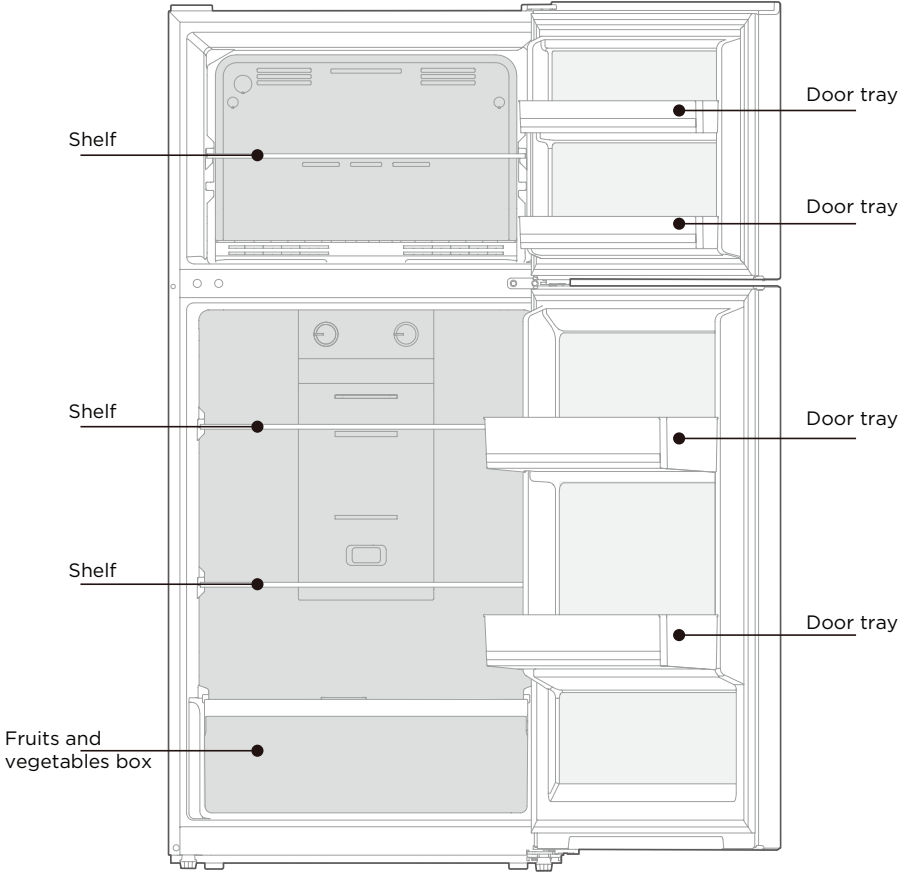

The picture above is only for reference. The actual configuration will depend on the physical product or statement by the distributor

Refrigerating chamber

- The refrigerating chamber is suitable for storage of a variety of fruits, vegetables, beverages and other short-term food, but the vegetables should be as far away from the refrigeration air supply outlet as possible.
- Hot food should not be put in the refrigerating chamber until cooled to room temperature.
- It is recommended that all food are sealed before putting into the refrigerator.
- The glass shelves can be adjusted up or down for a reasonable amount of storage space and easy use.

Freezing chamber

- The low temperature freezing chamber may keep food fresh for a long time and it is mainly used to store frozen food.
- The freezing chamber is suitable for the storage of meat, fish, and other food not to be consumed in short term.
- It is preferred that meat is divided into small pieces for quick freezing and easy access. Note that food should be consumed within the shelf time.

IMPORTANT:

Drawers, food boxes, shelves, etc. placed according to the position in the picture above are the most energy efficient.

NOTE

Storage of too much food during operation after the initial connection to power may adversely affect the freezing effect of the refrigerator. Food stored should not block the air outlet; otherwise the freezing effect will also be adversely affected. When storing beverages at the coldest setting, the fruits and vegetables inside are at risk of freezing. Set at a warmer temperature if the coldest setting is too cool.

2.6 FUNCTIONS

Temperature Controlling Knob

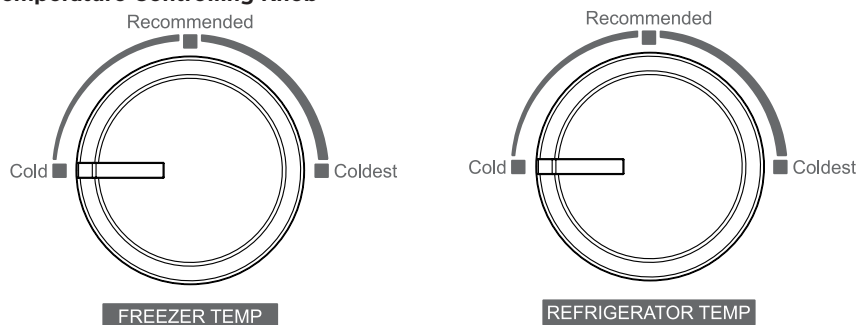

The picture above is only for reference. The actual configuration will depend on the physical product or statement by the distributor

Freezer temperature adjustment:

1. Adjust the temperature control knob to Cold, the temperature inside the freezer becomes the highest.
2. Adjust the temperature control knob to Coldest, the temperature inside the freezer becomes the lowest.
3. The word of the temperature control knob only represents the gear position, and does not specifically refer to a certain temperature.
4. The recommended gear is: Recommended.





Refrigerator temperature adjustment:

1. Adjust the temperature control knob to Cold, the temperature inside the refrigerating chamber becomes the highest.
2. Adjust the temperature control knob to Coldest, the temperature inside the refrigerating chamber becomes the lowest.
3. The word of the temperature control knob only represents the gear position, and does not specifically refer to a certain temperature.
4. The recommended gear is: Recommended.

2.7 REVERSE DOOR HINGES (OPTIONAL)

Precautions before operation:

- Before making changes, the refrigerator must be disconnected from power. Before adjusting the door, precautions should be taken to prevent any personal injury.

List of tools to be provided to the user			
	Phillips screwdriver		Putty knife, thin-blade screwdriver
	5/16" socket and ratchet		Masking tape

Parts to be used for door reverse			
SN	parts	Quantity	Notes
•	Upper hinge	•	Pre installed on the box and still needs to be used when changing the door
•	Upper hinge cover	•	Pre installed on the box and still needs to be used when changing the door
•	Upper hinge axle sleeve	•	Pre installed on the door and still needs to be used when changing the door
•	Upper hinge screw	•	Pre installed on the box and still needs to be used when changing the door
•	Hole cover	•	Pre installed on the box and still needs to be used when changing the door
•	Middle hinge screw	•	Pre installed on the box and still needs to be used when changing the door
•	Middle hinge	•	Pre installed on the box and still needs to be used when changing the door
•	Hole plug	•	Pre installed on the box and still needs to be used when changing the door
•	Adjustable foot	•	Pre installed on the box and still needs to be used when changing the door
••	Center sill screw	•	Pre installed on the box and still needs to be used when changing the door
••	Center sill screw cap	•	Pre installed on the box and still needs to be used when changing the door
••	Lower hinge screw	•	Pre installed on the box and still needs to be used when changing the door
••	Lower hinge	•	Pre installed on the box and still needs to be used when changing the door
••	Stopper	•	Pre installed on the door and still needs to be used when changing the door
••	Stopper screw	•	Pre installed on the door and still needs to be used when changing the door
••	Right door self-locking	•	Pre installed on the door body, removed when changing the door, and retained
••	Left door self-locking	•	Put it in the accessory bag and use it when changing the door
••	Screw self-locking	•	Pre installed on the door and still needs to be used when changing the door
••	Hole plug	•	Pre installed on the door and still needs to be used when changing the door

- 1) Unplug the refrigerator and take out all the food in the refrigerator;
- 2) Remove the right hinge cover, screws and upper hinge on the top of the box, and the hole cover on the left; take out the freezing door upwards.

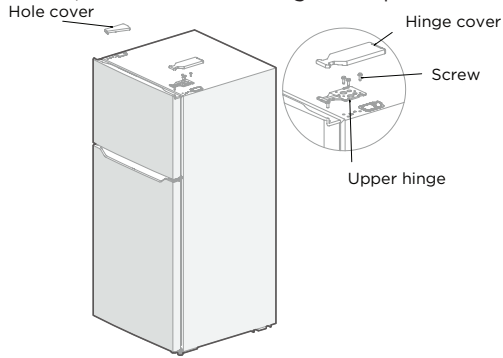

- 3) Unscrew the hinge screws, remove the middle hinge, remove the hole cover (plug screw), screw cap and middle beam screw on the middle beam, and take out the door body of the cold storage chamber upwards.

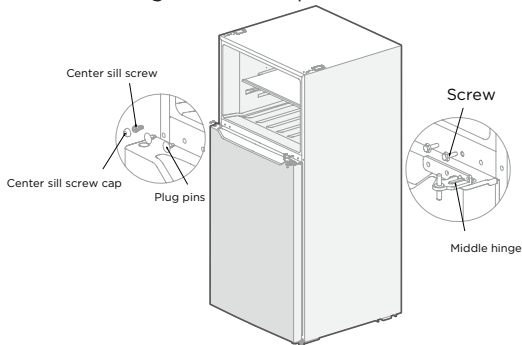

- 4) Put the refrigerator down, unscrew the lower hinge screw and leveling foot, remove the lower hinge, remove the lower hinge shaft and install it into the shaft hole on the other side of the hinge.

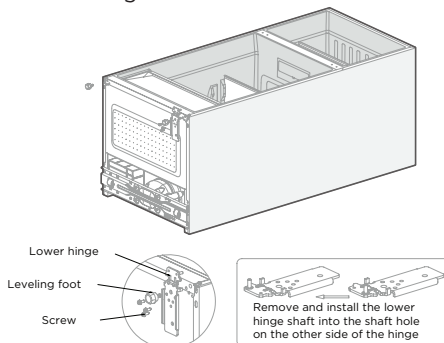

5) Install the lower hinge and tighten the screws on the left side of the refrigerator, install two leveling feet, and stand up the refrigerator.

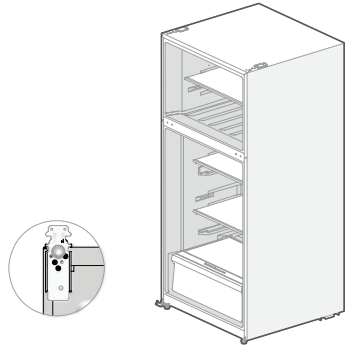

6) Unscrew and remove the shaft sleeves, door stops, and right door self-locking screws of the two door bodies. Take out the left door self-locking from the accessory bag, and install it to the left corner of the door body together with the door stops and shaft sleeves. Take out the hole plug and shaft sleeve on the upper part of the cold storage door and adjust their positions before installing them into the door body. Take out the shaft sleeve on the freezing door and install it on the other side.

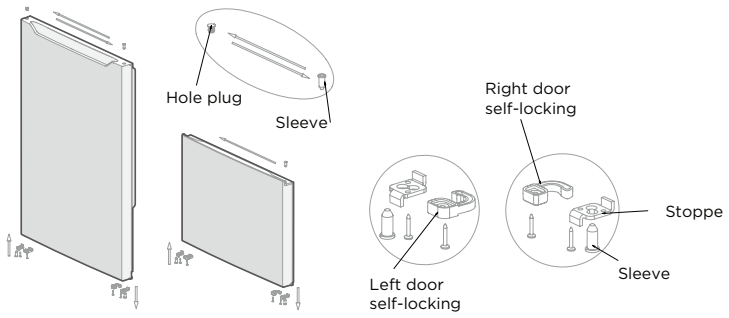

7) Install the refrigerated door on the lower hinge, install the center beam screws, center hinge and tighten the screws on the left side, and cover the hole cover (plug screw), center beam screws and screw caps on the right side.

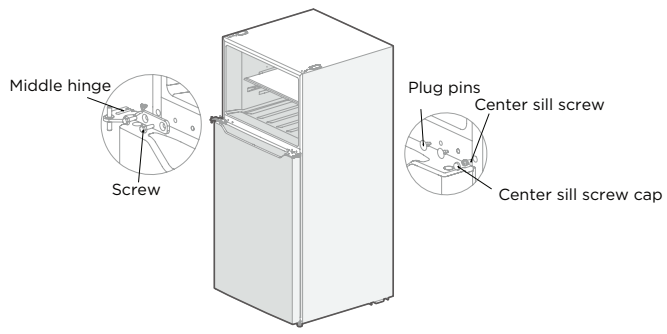

8) Install the freezing door onto the middle hinge, remove the upper hinge shaft and install it into the shaft hole on the other side of the hinge. Install the upper hinge and tighten the screws; then install the upper hinge cover and the right hole cover.

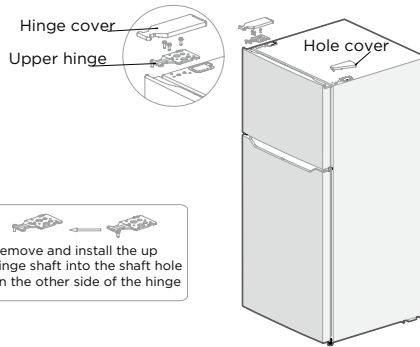

Remove and install the up hinge shaft into the shaft hole on the other side of the hinge

The picture above is only for reference. The actual configuration will depend on the physical product or statement by the distributor

2.8 LEVELING FEET

1) Precautions before operation:
Before making changes the refrigerator must be disconnected from power.

Before adjusting the leveling feet, precautions should be taken to prevent any personal injury.

2) Schematic diagram of leveling feet

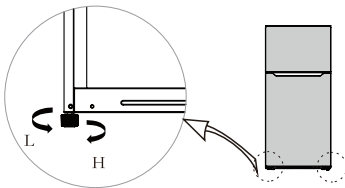

3) Adjusting procedures:

a. Turn the feet clockwise to raise the refrigerator.

b. Turn the feet counterclockwise to lower the refrigerator.

c. Adjust the right and left feet based on the procedures above to a horizontal level.

IMPORTANT:

The picture above is only for reference. The actual configuration will depend on the physical product or statement by the distributor

3. MAINTENANCE OF REFRIGERATOR

3.1 OVERALL CLEANING

- Dust behind the refrigerator and on the floor must be cleaned to improve the cooling effect and energy saving.
- Check the door gasket regularly to make sure there is no debris. Clean the door gasket with a soft cloth dampened with soapy water or diluted detergent.
- The interior of the refrigerator should be cleaned regularly to avoid odors.
- Turn off the power before cleaning the interior, and remove all food, drinks, shelves, drawers, etc.
- Use a soft cloth or sponge to clean the inside of the refrigerator with two tablespoons of baking soda and a quart of warm water. Then rinse with water and wipe clean. After cleaning, open the door and let it dry naturally before turning on the power.
- For areas that are difficult to clean inside the refrigerator (such as narrow places, gaps or corners), we recommend to wipe them regularly with a soft rag, soft brush, etc. and when necessary, with some tools (such as thin sticks) to ensure no contaminants or bacteria accumulated in these areas.
- Do not use soap, detergent, scrub powder, spray cleaner, etc., as these may cause odors inside the refrigerator or it may contaminate food.
- Clean the door tray, shelves and drawers with a soft cloth dampened with soapy water or diluted detergent. Dry with a soft cloth or dry naturally.
- Wipe the outer surface of the refrigerator with a soft cloth dampened with soapy water, detergent, etc., and then wipe dry.
- Do not use hard brushes, scouring pads, wire brushes, abrasives (such as toothpaste), organic solvents (such as alcohol, acetone, banana oil, etc.), boiling water, acid or alkaline items, which may damage the fridge surface and interior. Boiling water and organic solvents such as benzene may deform or damage plastic parts.
- Do not rinse directly with water or other liquids during cleaning to avoid short circuit or affect electrical insulation after immersion.



Unplug the refrigerator for defrosting and cleaning.

3.2 DEFROSTING

- Frost formed due to change of season or temperature may be manually removed by disconnecting the appliance from the power supply or by wiping with a dry towel.

3.3 OUT OF OPERATION

- Power failure: In case of power failure, even in summer, food inside the appliance can be kept for several hours. During the power failure, the amount of times of opening the doors must be reduced, and no additional fresh food should be placed into the appliance.
- Long-term non-use: Unplug and clean the appliance and leave the doors open to prevent odors.
- Moving: Before the refrigerator is moved, take all objects out, fix the glass partitions, vegetable holder, etc. with tape, and tighten the leveling feet; close the doors and fix them with tape. During the move, the appliance must not be laid upside down, horizontally, or be exposed to strong vibration; the inclination during the move should be no more than 45°.

IMPORTANT:

The appliance should run continuously once it is started. Generally, the operation of the appliance should not be interrupted; otherwise the service life may be impaired

4. TROUBLESHOOTING

The following simple issues can be handled by the user. Call the after-sale service department if the issues are not solved.

Malfunction	<ul style="list-style-type: none"> • Check whether the appliance is connected to power or whether the plug is inserted properly. • Check whether the voltage is too low. • Check whether there is a power failure or circuits have tripped.
Odor	<ul style="list-style-type: none"> • Odorous food should be tightly wrapped. • Check whether there is any rotten food. • Clean the inside of the refrigerator.
Long operation of the compressor	<ul style="list-style-type: none"> • Long operation of the refrigerator is normal in summer when the ambient temperature is high. • We do not suggest placing too much food in the appliance at the same time. • Food must cool down before being placed in the appliance. • The doors are opened too frequently.
Light fails to turn on	<ul style="list-style-type: none"> • Check whether the refrigerator is connected to power supply and whether the illuminating light is damaged. • Have the light replaced by a specialist.
Door cannot be properly closed	<ul style="list-style-type: none"> • The door is stuck by food packages. • The refrigerator is tilted.
Loud noises	<ul style="list-style-type: none"> • Check whether the floor is level and whether the refrigerator is placed in a stable position. • Check whether accessories are placed at proper locations.
Door seal fails to be tight	<ul style="list-style-type: none"> • Remove foreign matters on the door seal. • Heat the door seal and then cool it for restoration (or blow it with an electrical dryer or use a hot towel for heating).
Water pan overflows	<ul style="list-style-type: none"> • There is too much food in the chamber or food stored contains too much water, resulting in heavy defrosting. • The doors are not closed properly, resulting in frosting due to entry of air and increased water due to defrosting.
Hot housing	<ul style="list-style-type: none"> • Heat dissipation of the built-in condenser via the housing, which is normal. When the housing becomes hot due to high ambient temperature, storage of too much food or shutdown of the compressor, provide good ventilation to facilitate heat dissipation.
Surface condensation	<ul style="list-style-type: none"> • Condensation on the exterior surface and door seals of the refrigerator is normal when the ambient humidity is too high. Just wipe the condensate with a clean towel.
Abnormal noise	<ul style="list-style-type: none"> • Buzz: The compressor may produce buzzes during operation, and the buzzes are loud particularly upon start or stop. This is normal. • Creak: Refrigerant flowing inside the appliance may produce a creak, which is normal.

5. APPENDIX

Installation Instructions

For refrigerating appliances with climate class

Depending on the climate class, this refrigerating appliance is intended to be used at ambient temperature ranges as specified by the following table. The climate class can be found on the rating plate. The product may not operate properly at temperatures outside of the specified range.

You can find the climate class on the label inside your refrigerator

Effective temperature range

The refrigerator is designed to operate normally in the temperature range specified by its class rating.

Class	Symbol	Ambient temperature range °F	
		IEC 62552 (ISO 15502)	ISO 8561
Extended temperate	SN	+50 to +89.6	+50 to +89.6
Temperate	N	+60.8 to +89.6	+60.8 to +89.6
Subtropical	ST	+60.8 to +100.4	+60.8 to +100.4
Tropical	T	+60.8 to +109.4	+60.8 to +109.4

NOTE

The cooling performance and power consumption of the refrigerator may be affected by the ambient temperature, the door-opening frequency, and the location of the refrigerator. We recommend adjusting the temperature settings as appropriate.

How to store for best preservation (applicable models only)

Cover food to retain moisture and prevent them from picking up odors from other food. A large pot of food, like soup or stew, should be divided into small portions and put in shallow containers before being refrigerated. A large cut of meat or whole poultry should be divided into smaller pieces or placed in shallow containers before being refrigerated.

Placement of foods

Shelves	<ul style="list-style-type: none"> Shelves are adjustable to accommodate a variety of packages.
Specialized compartment (applicable models only)	<ul style="list-style-type: none"> Sealed crisper drawers provide an optimal storage environment for fruit and vegetables. Vegetables require higher humidity while fruit requires lower humidity. Crispers are equipped with control devices to control the humidity level (*depending on model and options). An adjustable temperature meat drawer maximizes the storage time of meat and cheese.
Storage in the door	<ul style="list-style-type: none"> Do not store perishable food in the door. Eggs should be stored in the carton on a shelf. The temperature of the storage bins in the door fluctuates more than the temperature inside the cabinet. Keep the door closed as much as possible.
Freezer compartment	<ul style="list-style-type: none"> You can store frozen food and freeze fresh food in the freezer compartment.

NOTE

Freeze fresh, undamaged food only. Keep food which is to be frozen away from food which is already frozen. To prevent food from losing its flavor or drying out, place in airtight containers.

Refrigerator & Freezer Storage Chart

The shelf life depends on the temperature and exposure to moisture. Since product dates are not a guide for the safe use of a product, consult this chart and follow these tips.

Milk products

Product	Refrigerator	Freezer
Milk	1 week	1 month
Butter	2 weeks	12 months
Ice cream	-	2 - 3 weeks
Natural cheese	1 month	4 - 6 months
Cream cheese	2 weeks	Not recommended
Yogurt	1 month	-

Meat

Product	Refrigerator	Freezer
Fresh roasts, steaks, chops	3 - 4 days	2 - 3 months
Fresh ground meat, stew meat	1 - 2 days	3 - 4 months
Bacon	7 days	1 month
Sausage, raw from pork, beef, turkey	1 - 2 days	1 - 2 months

Poultry / Eggs

Product	Refrigerator	Freezer
Fresh poultry	2 days	6 - 8 months
Poultry salad	1 day	-
Eggs, Fresh in shell	2 - 4 weeks	Not recommended

Fish / Seafood

Product	Refrigerator	Freezer
Fresh fish	1 - 2 days	3 - 6 months
Cooked fish	3 - 4 days	1 month
Fish salad	1 day	Not recommended
Dried or pickled fish	3 - 4 weeks	-

Fruit

Product	Refrigerator	Freezer
Apples	1 month	-
Peaches	2 - 3 weeks	-
Pineapple	1 week	-
Other fresh fruit	3 - 5 days	9 - 12 months

Vegetables

Product	Refrigerator	Freezer
Asparagus	2 - 3 days	-
Broccoli, Brussels sprouts, green peas, mushrooms	3 - 5 days	-
Cabbage, cauliflower, celery, cucumbers, lettuce	1 week	-
Carrots, beets, radishes	2 weeks	-

SPECIAL FOR NEW EUROPEAN STANDARD

The ordered parts in the following table can be acquired through the service provider

Ordered part	Provided by	Minimum time required for provision
Thermostat	Professional maintenance personnel	At least 7 years after the model was launched
Temperature sensor	Professional maintenance personnel	At least 7 years after the model was launched
Printed circuit board	Professional maintenance personnel	At least 7 years after the model was launched
Light source	Professional maintenance personnel	At least 7 years after the model was launched
Door handle	Professional repairers and final users	At least 7 years after the model was launched
Door hinges	Professional repairers and final users	At least 7 years after the model was launched
Trays	Professional repairers and final users	At least 7 years after the model was launched
Baskets	Professional repairers and final users	At least 7 years after the model was launched
Door gaskets	Professional repairers and final users	At least 10 years after the model was launched

Dear customer,

1. If you want to return or replace the product, please contact the store where you bought it.
2. Remember to bring proof of purchase.
3. If your product breaks down and needs to be repaired, please contact the after-sales service provider.

6. WARRANTY

Element Appliance Limited Warranty

(the “Products” or “Product” when referencing a singular product herein)

This Product (including any accessories included in the original packaging) as supplied and distributed in new condition, is warranted by Element Appliance Company, LLC (“Element”) to the original customer who purchases the Product from an authorized Element retailer (the “Original Customer” or “you”) against defects in material and workmanship under proper use, maintenance, and care according to the owner’s manual, warnings, and instruction accompanying the Product (“Warranty”) as follows:

* **PLEASE NOTE** – Proof of purchase evidencing the date of purchase by the Original Purchaser from an authorized Element retailer (“Valid Proof of Purchase”) is **required** for all Warranty service. The express Warranty set forth herein is subject to all terms and conditions set forth below.

1. WARRANTY SERVICE:

A. ONE-YEAR WARRANTY: Except as provided in subpart 1.B below, for a period of **one (1) year** from the date of purchase by the Original Customer (the “Warranty Period”), if the parts or components covered by this Warranty are determined by Element or Element’s authorized service provider to be defective in material or workmanship, Element will, at its sole and absolute discretion and option: (i) repair the defective part or component at no charge to the Original Customer, (ii) replace the defective Product with a new Product of similar or better quality, at no charge to the Original Customer, or (iii) refund the documented purchase price paid by the Original Customer (excluding tax) to the Original Customer upon return of the defective Product as directed by Element. After the Warranty Period expires, the Original Customer must pay for all parts, components, shipping and handling, labor, and replacement costs associated with the Product or any part or component thereof, regardless of any defects in the Product or any part or component thereof.

B. LIMITED EXTENDED WARRANTY THROUGH PRODUCT REGISTRATION: If and only if the Original Customer registers the Product at www.elementelectronics.com within **ninety (90)** days of the date of purchase by the Original Customer, then the Warranty Period discussed in subpart 1.A. above shall be extended an additional one (1) year to a new Warranty Period equaling **two (2) years** from the date of purchase by the Original Customer. If the Product is not registered as provided for in this subpart 1.B, then the standard one-year Warranty Period set forth in subpart 1.A shall apply.

C. TIMING AND PROCEDURE: Before Warranty service can commence, the Original Customer must contact either (i) the retailer from whom the Original Customer purchased the Product, or (ii) Element directly, in either case for problem determination and service procedures. Valid Proof of Purchase evidencing that the Product is within the Warranty Period **MUST** be presented by Original Customer in order to obtain the requested Warranty service. Please have your model and serial number available, along with your date of purchase of the Product. To remain eligible for Warranty service, Original Customer may not return the Product or any part or component thereof to the retailer or Element without Element’s prior written consent.

2. EXCLUSIONS AND LIMITATIONS TO WARRANTY SERVICE

The Warranty covers manufacturing defects in materials and workmanship of the Product encountered in the normal, non-commercial use of the Product, and **does not cover** (a) damages or malfunctions resulting from improper or unreasonable use or maintenance, abuse, negligence, failure to follow instructions contained in any written materials that accompany the Product, deterioration by reason of excess moisture, corrosive atmosphere, lightning, power surges, connections to improper voltage supply, unauthorized alteration, or other external causes such as extremes in temperature or humidity, modifications, scratches or discoloration; (b) improper or incorrectly performed repairs by service providers not authorized by Element; (c) transportation, shipping, delivery, pickup, insurance, installation, or set-



up costs; (d) ordinary wear and tear, cosmetic damage, or damage due to acts of nature, including but not limited to, water, floods, wind, storm, tornado, earthquake, or fire, or due to damage caused by extraordinary impact events, such as dropping, crushing, demolition or other extraordinary damage; (e) commercial use of the Product, or use of the Product for anything other than single-family household or residential use; or (f) modification of the Product or any part of the Product.

This Warranty is made to the Original Customer only and does not cover Products sold AS IS or WITH ALL FAULTS. The Warranty is invalid if the factory-applied serial number has been altered or removed from the Product. This Warranty is valid only in the United States, and only applies to Product if it was purchased and serviced in the United States. The addition of equipment or features to the Product that are not manufactured or recommended by Element could affect the intended function of the Product, and therefore may void the Warranty. Furthermore, the exposure of the Product to chemicals, heat, cold, humidity, or other elements can affect the Product components, and therefore, the Warranty does not cover discoloration, fading, cosmetic changes, rust, or any damages or failure related to any such items. The Warranty is contingent upon the proper use, maintenance, and care of the Product. The Warranty may be void if the Product has been used in a manner contradictory to, or in violation of, the terms of the user's manual, warnings, or instructions accompanying the Product.

THIS WARRANTY IS MADE IN LIEU OF AND SUPERSEDES ALL OTHER WARRANTIES OR CONDITIONS OF MERCHANTABILITY OR FITNESS FOR A PARTICULAR PURPOSE OR GENERAL USE, WHETHER EXPRESS, IMPLIED, COLLATERAL, STATUTORY, OR PROVIDED BY COMMON LAW, THE UNIFORM COMMERCIAL CODE, OR OTHERWISE. ELEMENT FURTHER DISCLAIMS ALL WARRANTIES AFTER THE END OF THE WARRANTY TERM DEFINED ABOVE. NO OTHER EXPRESS WARRANTY OR GUARANTY GIVEN BY ANY OTHER PERSON, FIRM, OR ENTITY WITH RESPECT TO THE PRODUCT SHALL BE BINDING ON ELEMENT. REPAIR, REPLACEMENT, OR REFUND OF THE ORIGINAL PURCHASE PRICE, AT ELEMENT'S SOLE DISCRETION, ARE THE EXCLUSIVE REMEDIES OF THE CUSTOMER.

ELEMENT SHALL NOT BE LIABLE FOR ANY INCIDENTAL OR CONSEQUENTIAL DAMAGES CAUSED BY THE USE, MISUSE, OR INABILITY TO USE THE PRODUCT. THESE INCLUDE, BUT ARE NOT LIMITED TO, ANY DAMAGES IN THE FORM OF LOST PROFITS, LOSS OF USE, LEGAL FEES, ECONOMIC LOSS, PERSONAL INJURIES, OR ANY OTHER DAMAGES CAUSED BY CIRCUMSTANCES BEYOND THE CONTROL OF ELEMENT. NOTWITHSTANDING THE FOREGOING, ELEMENT'S AGGREGATE LIABILITY TO ANY CUSTOMER SHALL NOT EXCEED THE ORIGINAL PURCHASE PRICE OF THE PRODUCT. THIS WARRANTY SHALL NOT EXTEND TO ANYONE OTHER THAN THE ORIGINAL CUSTOMER WHO PURCHASED THE PRODUCT, AND IS NOT TRANSFERABLE. NO PERSON IS AUTHORIZED TO ALTER, EXTEND, OR WAIVE THIS WARRANTY OR ANY OF ITS TERMS OR CONDITIONS.

Some states do not allow the exclusion or limitation of incidental or consequential damages, or allow limitations on warranties, so the above limitations or exclusions may not apply to you. This Warranty gives you specific rights, and you may have other rights, which vary from state to state. The exclusions and limitations to the Warranty apply to the maximum extent permitted by law and unless restricted or prohibited by law. Where any term of this Warranty is prohibited by applicable law, it shall be null and void, but the remainder of this Warranty shall remain in effect.

PLEASE DIRECT ALL CORRESPONDENCE TO:

Element Appliance Company, LLC
customerservice@elementelectronics.com
(888) 842-3577
<https://elementelectronics.com>





CONTACT US:

Element, the Element Logo, and Bring it home are trademarks of Element Brand Holding, LLC. All other trademarks are the property of their respective owner, who has not sponsored, endorsed, or approved this product. ©2022 Element Appliance Company, LLC. All rights reserved.

Distributed by Element Appliance Company, LLC
Augusta, GA 30909

For service, support and warranty information:
Call 888.842.3577, email us at customerservice@elementelectronics.com or visit www.elementelectronics.com