

PROPANE CONVERSION INSTRUCTIONS

⚠ WARNING Explosion Hazard

Death or serious injury can result from failure to follow these instructions.

- Service by a qualified service technician only.
- Shut off gas supply and disconnect power before servicing.
- Reconnect all grounding devices after service.
- Replace all parts and panels before operating.

The pressure regulator and the burner orifices are set for natural gas. To use propane gas, the regulator and burner orifices must be converted.

⚠ WARNING

Do not operate the cooktop or oven burners of this range when using propane (bottled) gas before converting the pressure regulator and burner orifices for propane gas use. Failure to do so could cause high flames and toxic fumes which can result in serious injury.

The propane orifices for the cooktop burners are shipped on the back of the range in the location shown.

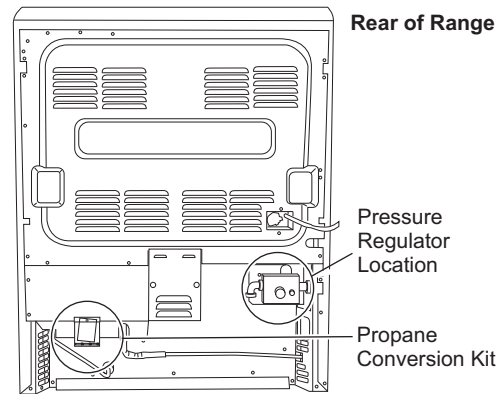

TOOLS REQUIRED:

- Adjustable wrench
- Socket wrench with 1/2" socket and extension
- Phillips head screwdriver
- Flat bladed screwdriver (blade approximately 3/32" across)
- Nut drivers: 1/4", 9/32" or 7mm

To adjust your range for use with propane gas, follow these instructions:

1. Disconnect all electrical power, at the main circuit breaker or fuse box.
2. Shut off the gas supply to the range by closing the manual shut-off valve.

CONVERTING THE PRESSURE REGULATOR

1. Use an adjustable wrench to unscrew the hex-nut cap from the pressure regulator.
2. Completely remove the protective plastic cap off the threaded metal cap.

Rotate cap counter-clockwise to loosen

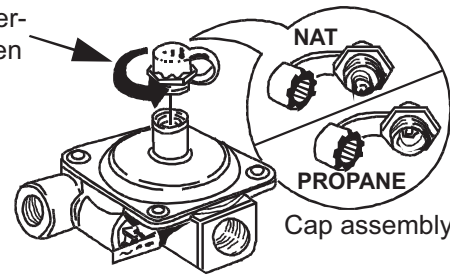

Regulator

3. Turn the metal cap so the type of gas being converted to is displayed and replace the protective plastic cover.
4. Screw the hex-nut cap back into the regulator. **(Do not over tighten)**

CONVERTING THE COOKTOP BURNERS

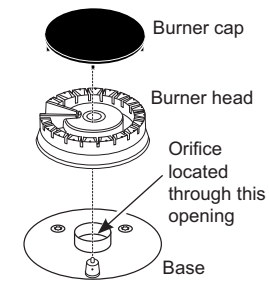

Round burner

- A. Remove the top grates, burner caps and burner heads.
- B. Using a 7 mm or 9/32" nut driver, remove the top burner orifices. These may be accessed through the burner opening in the base.
- C. Remove the propane orifices from the box provided. The

NOTICE:

Save these orifices for future conversion back to natural gas.

propane orifices have the letter "L" on the top.

To aid in identifying the proper location for the propane orifices during conversion from Natural Gas to Propane Gas, color codes have been added to the side or top of the orifice. See the chart below. Each orifice may also show a series of engraved marks (I, II, III . . .) located on the top.

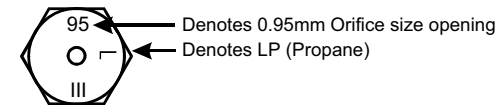

BURNER OUTPUT RATINGS: BTU/HR

Propane Gas 10" W.C.P.

BURNER	BTU RATE	ORIFICE SIZE (in)	COLOR	MARKING
LF	18,000	0.049	None	125L
LR	5,000	0.026	Red/Yellow	66L
RF	15,000	0.045	Orange/Silver	114L
RR	9,500	0.0365	Orange/Light Blue	92L
C	8,000	0.034	Orange/Green	86L
Upper Bake	7,000	0.031	Brown	031L
Broil	13,500	0.042	Grey	042L
Lower Bake	13,500	0.043	Green	043L

- D. Install the propane orifices in their precise locations.

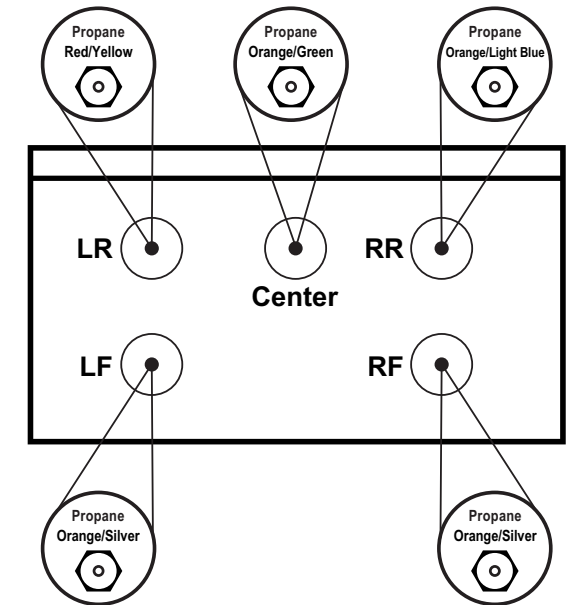

To prevent leakage, make sure the orifice spuds are securely screwed into the gas supply tubes.

- E. Install the old orifice spuds into the metal box or bracket along with these instructions, and replace onto the back of the range for possible future conversion.

CHECK SURFACE BURNERS

Push and turn a knob to the LITE position. A clicking sound indicates proper operation of the ignition system. When lighting any burner, sparks will appear at all burners but gas flows from only the one selected. Once air is purged from the supply line, burner should light within 4 seconds. After burner lights, rotate the knob out of the LITE position. Try each burner in succession until all burners have been checked.

Quality of Flames

Determine the quality of flames visually. Normal burner flames should look like (A) or (B).

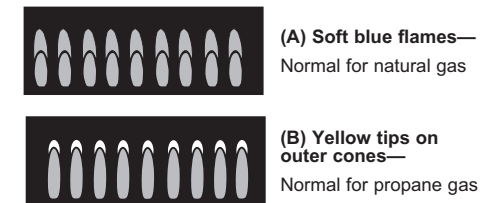

Long, bright yellow flames are not normal. Normal flames may show signs of an orange tint when well heated or signs of flickering orange due to particles in the gas or air.

PROPANE CONVERSION INSTRUCTIONS

31-2000722 Rev. 1 11-23

JGSS86

CONVERTING THE OVEN BURNERS

NOTICE:

This product cannot be converted to propane by adjusting the oven orifices. The orifices must be replaced for propane.

UPPER AND LOWER OVEN BAKE BURNER ORIFICES

1. Remove the lower oven door from the unit
2. Remove oven racks, oven bottoms and flame spreaders from both ovens. In the lower oven, remove the enclosure around the rear of the bake burner held in place by three Phillips screws.
3. Remove all 1/4" hex screws securing the bake burners. Gently slide each bake burner to the left to remove it from the orifice and allow burners to rest on the bottom of their respective ovens.
4. With a 1/2" wrench, loosen each orifice by turning counter-clockwise and remove.

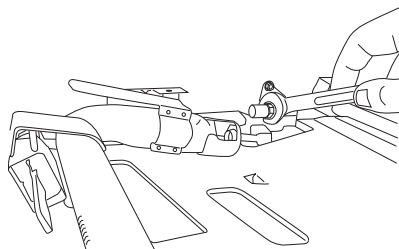

NOTICE:

Save these orifices for future conversion back to natural gas.

5. Select the appropriate bake orifice for each oven from the kit and install on the threaded fittings. Tighten with wrench until snug.
6. Gently replace the bake burners over their respective orifices and replace all 1/4" hex screws securing the burners.

BROIL BURNER ORIFICE

1. Remove the 1/4" hex screw securing the broil burner and allow it to hang down free of the broil orifice.
2. Apply a 1/2" wrench to the hex base of the orifice. Loosen the orifice by turning counter-clockwise and remove.

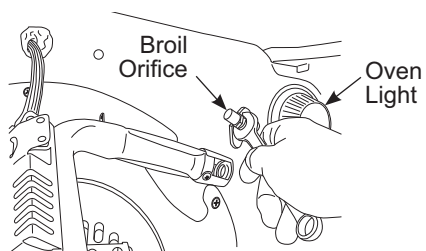

NOTICE:

Save these orifices for future conversion back to natural gas.

3. Select the propane broil orifice from the kit and install it on the broil elbow. Tighten until snug.
4. Replace the broil burner over the orifice and replace the screw securing the burner.

ADJUSTING AIR SHUTTER SETTINGS FOR OVEN BURNERS

The air shutters should be turned to the marked settings NG or propane or set according to the following table.

BURNER	AIR SHUTTER SETTING FOR PROPANE	AIR SHUTTER SETTING FOR NG
Lower Oven Broil Burner	0.690	0.690
Upper Oven Bake Burner	0.750	0.750
Lower Oven Bake Burner	0.400	0.250

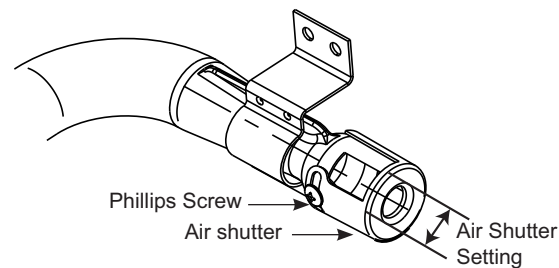

With a Phillips head screwdriver, loosen the screws securing the air shutters on the burners and adjust the air shutters according to chart.

Bake and broil flames must be checked with the oven doors closed to properly check flame characteristics.

1. Turn on the gas.
2. Turn on the electricity.
3. Reinstall the lower oven door. Close both doors.
4. Turn on both bake burners.
5. For each burner, observe the following through the oven door windows.
 - a. If the flames are yellow, open the air shutter more.
 - b. If the flames blow away or flutter from the burner, close the air shutter slightly, but not by more than 1/8".
6. Turn bake burner off and repeat with broil burner.

WARNING

If you attempt to measure the inner cone of the flame, please use caution: burns could result.

Oven burner flame must be observed with the door closed to properly check flame characteristics.

7. Checking the flame size: It should be approximately 1/2" to 3/4" long for the bake and broil burners. The combustion quality of the burner flames needs to be determined visually.

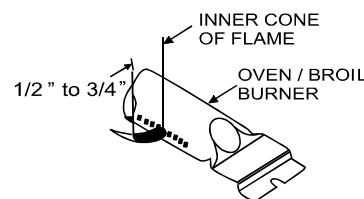

NOTE: If burner flames look like (A), further air shutter adjustment to the bake burner is required. Normal burner flames should look like (B) or (C), depending on the type of gas you use. With propane gas, some yellow tipping on the outer cones is normal.

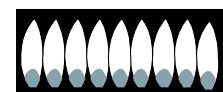

(A) Yellow flames: Further Adjustment Required



(B) Yellow tips on outer cones: Normal for Propane Gas



(C) Soft blue flames: Normal for Natural Gas

Foreign particles in the gas line may cause an orange flame at first, but this will soon disappear.

8. Retighten the air shutter screws.
9. When all adjustments are made and the results are satisfactory:
 - a. Replace the enclosure around the rear of the bake burner in the lower oven.
 - b. Replace the flame spreaders.
 - c. Replace the oven bottoms and oven racks.

ADJUSTING LOW FLAME SETTING ON COOKTOP BURNERS

Low setting adjustments must be made with other burners in operation on a medium setting. This procedure prevents the low flame from being set too low, resulting in the flame being extinguished when other burners are turned on.

- A. Turn on all surface burners to medium setting.
- B. Turn the knob on the burner being adjusted to "LO".
- C. Remove the knob and insert a small, flat blade screwdriver into the valve shaft and/or side adjustment screw(s) as shown and turn clockwise to fully tighten down the bypass screw(s). Repeat for all valves.
- D. If flame appears too low or unstable, slowly turn bypass screw counterclockwise until a stable flame exists for each burner. Remember, other burners must be turned on to medium.
- E. Additionally, for each burner being adjusted, quickly open and close the oven door while observing flame. If flame is extinguished, continue adjusting bypass screw for a larger flame. Repeat door openings until flame is stable.
- F. Replace the knob.

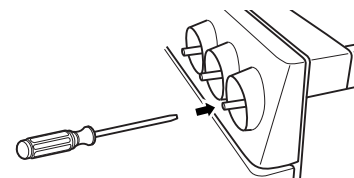

Center adjustment screw only for all other burners.

SPECIAL NOTE:

To convert the oven back to natural gas, reverse the instructions given in making propane adjustments.

NOTICE:

Once the conversion is complete and confirmed, fill out the propane sticker and include your name, organization and date conversion was made. Apply the sticker to the range near the regulator to alert others in the future that this appliance has been converted to propane. If converting back to natural gas from propane, please remove the sticker so others know the appliance is set to use natural gas.

ADDITIONAL INFORMATION

BURNER OUTPUT RATINGS: BTU/HR

NG (Natural) Gas 5" W.C.P.

BURNER	BTU RATE	ORIFICE SIZE (in)	COLOR	MARKING
LF	18,000	0.078	Purple	198N
LR	5,000	0.040	White/Purple	101N
RF	15,000	0.070	Brown	178N
RR	9,500	0.0555	Yellow	141N
C	10,000	0.055	Yellow	140N
Upper Bake	7,000	0.046	Yellow	046N
Broil	16,500	0.071	Black/Blue	071N
Lower Bake	14,000	0.066	Red	066N

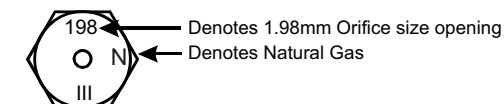

198

Denotes 1.98mm Orifice size opening

Denotes Natural Gas

N

III

III

III

III

III

III

III

III

III

III

III

III

III

III

III

III

III

III

III

III

III

III

III

III

III

III

III

III

III

III

III

III

III

III

III

III

III

III

III