

DIMENSIONS

BUILT-IN MICROWAVES WITH TRIM KITS

PRODUCT DIMENSIONS

MODEL #	SLIM TRIM KIT MODELS WMT50011K / KMBT5011K		STANDARD TRIM KIT MODELS WMT55511K / KMBT5511K	
	in	cm	in	cm
Overall width of microwave (A)	27 ¹³ / ₁₆	70.7	27 ¹³ / ₁₆	70.7
Overall height of microwave (B)	10 ⁵ / ₁₆	26.2	10 ⁵ / ₁₆	26.2
Height of the door (C)	10 ⁵ / ₁₆	26.2	10 ⁵ / ₁₆	26.2
Depth without door (D)	16 ³ / ₈	41.6	16 ³ / ₈	41.6
Depth with door (E)	18	45.7	18	45.7
Depth with door open 90° (F)	42 ¹ / ₈	107	42 ¹ / ₈	107
Distance from fixed wall to door open 90° (G)	1/2	1.3	1/2	1.3

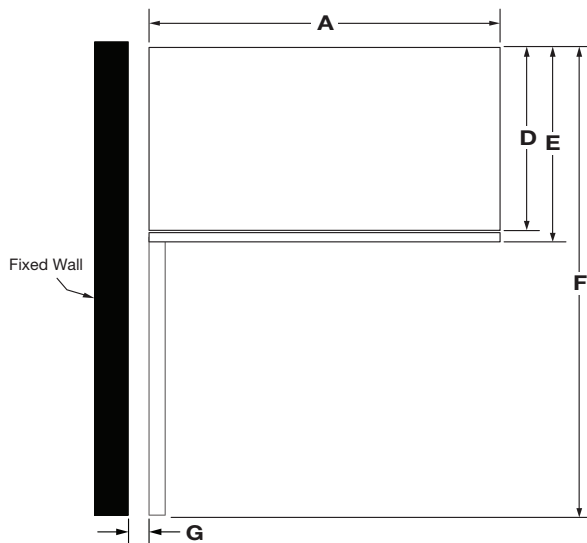
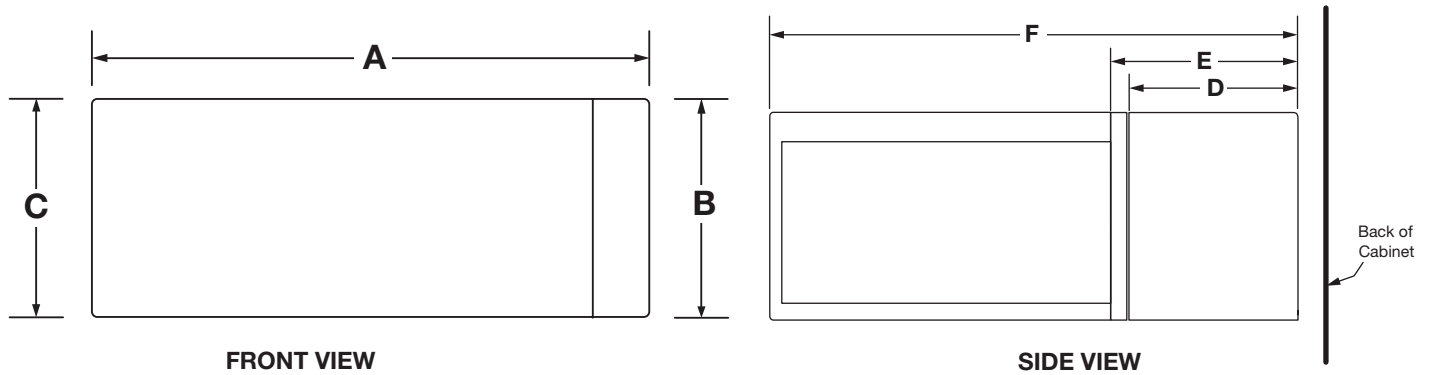

IMPORTANT: Dimensional specifications are provided for planning purposes only. Do not make any cutouts based on this information. Refer to the Installation Guide before selecting cabinetry, verifying electrical/gas connections, making cutouts or beginning installation. All Whirlpool® appliances are appropriately UL, CUL or CSA approved.

TRIM KIT FRAME DIMENSIONS

MODEL #	SLIM TRIM KIT MODELS WMT50011K / KMBT5011K		STANDARD TRIM KIT MODELS WMT55511K / KMBT5511K	
	in	cm	in	cm
Overall width of trim kit frame (H)	29 ³ / ₄	75.6	29 ³ / ₄	75.6
Overall height of trim kit frame (J)	14	35.6	19 ¹ / ₈	48.6
Trim kit frame inner opening height (K)	10 ⁹ / ₁₆	26.9	10 ⁹ / ₁₆	26.9
Width of trim kit inner opening (L)	28	71.1	28	71.1
Depth of trim kit frame (M)	2 ⁵ / ₁₆	5.8	2 ⁵ / ₁₆	5.8
Trim kit frame thickness (visible) (N)	7/8	2.2	7/8	2.2

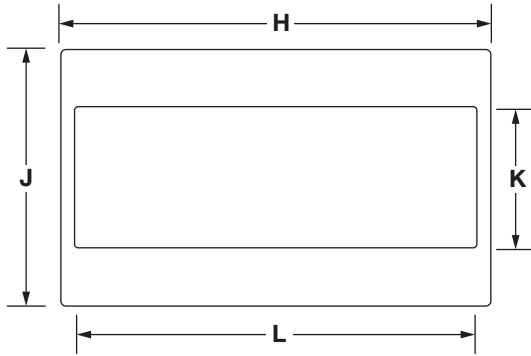

FRONT VIEW

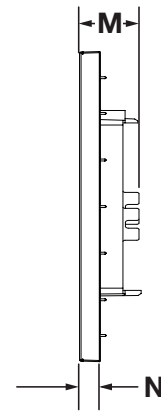

SIDE VIEW

IMPORTANT: Dimensional specifications are provided for planning purposes only. **Do not make any cutouts based on this information.** Refer to the Installation Guide before selecting cabinetry, verifying electrical/gas connections, making cutouts or beginning installation. All Whirlpool® appliances are appropriately UL, CUL or CSA approved.

DIMENSIONS

DIMENSION AS INSTALLED

MODEL #	SLIM TRIM KIT MODELS WMT50011K / KMBT5011K		STANDARD TRIM KIT MODELS WMT55511K / KMBT5511K	
	in	cm	in	cm
Opening/Clearance Measurement				
Height of the door (A)	10 ⁵ / ₁₆	26.2	10 ⁵ / ₁₆	26.2
Overall height of trim kit frame (B)	14	35.6	19 ¹ / ₈	48.6
Overall height of microwave (C)	10 ⁵ / ₁₆	26.2	10 ⁵ / ₁₆	26.2
Overall height with rail (D)	11 ³ / ₁₆	28.3	11 ³ / ₁₆	28.3
Depth with door (E)	18	45.7	18	45.7
Depth with door open 90° (F)	42 ¹ / ₈	93.7	42 ¹ / ₈	93.7
Trim kit frame overhang-upper frame (G)	1	2.6	1	2.6
Trim kit frame overhang-lower frame (H)	1	2.6	1	2.6
Overall width of trim kit frame (J)	29 ³ / ₄	75.6	29 ³ / ₄	75.6
Overall height of microwave (K)	10 ⁵ / ₁₆	26.2	10 ⁵ / ₁₆	26.2
Overall height of trim kit frame (L)	14	35.6	19 ¹ / ₈	48.6
Trim kit frame overhang-left frame (M)	5/8	1.6	5/8	1.6
Trim kit frame overhang-right frame (N)	5/8	1.6	5/8	1.6
Distance from fixed wall to door open 90° (P)	1/2	1.3	1/2	1.3

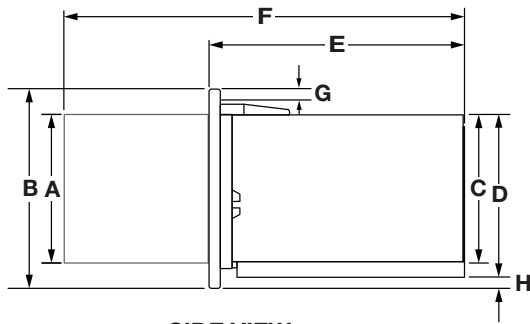

SIDE VIEW

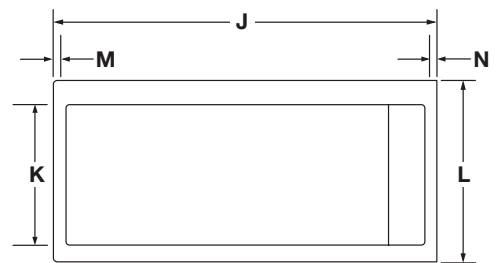

FRONT VIEW

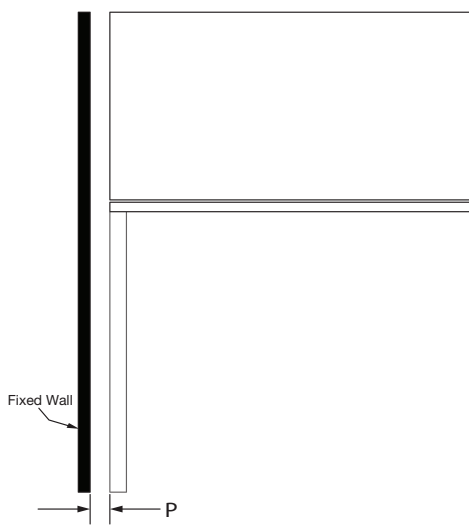

TOP VIEW

IMPORTANT: Dimensional specifications are provided for planning purposes only.

Do not make any cutouts based on this information. Refer to the Installation Guide before selecting cabinetry, verifying electrical/gas connections, making cutouts or beginning installation. All Whirlpool® appliances are appropriately UL, CUL or CSA approved.

DIMENSIONS

MICROWAVE INTERIOR CAVITY DIMENSIONS

MODEL #	SLIM TRIM KIT MODELS WMT50011K / KMBT5011K		STANDARD TRIM KIT MODELS WMT55511K / KMBT5511K	
	in	cm	in	cm
Unit of Measurement				
Cavity Height (J)	7	17.7	7	17.7
Cavity Height from the Highest Point of the Turntable (K)	6 ⁷ / ₈	17.5	6 ⁷ / ₈	17.5
Cavity Width (L)	18 ⁷ / ₈	48	18 ⁷ / ₈	48
Cavity Depth (M)	14	35.6	14	35.6
Turntable Diameter (N)	12	30.5	12	30.5

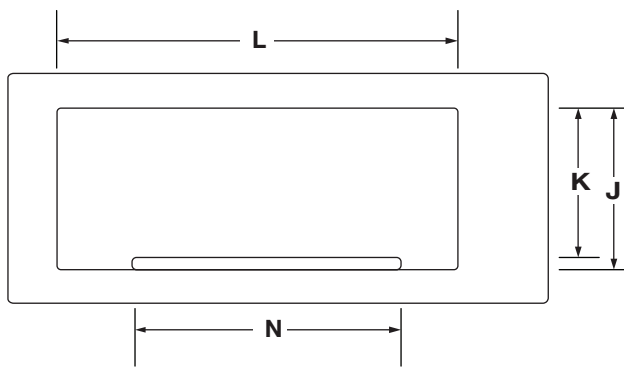

FRONT VIEW

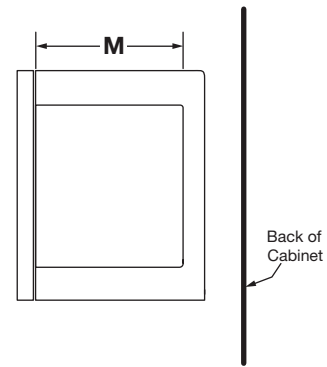

SIDE VIEW

IMPORTANT: Dimensional specifications are provided for planning purposes only. Do not make any cutouts based on this information. Refer to the Installation Guide before selecting cabinetry, verifying electrical/gas connections, making cutouts or beginning installation. All Whirlpool® appliances are appropriately UL, CUL or CSA approved.

OPENING/CLEARANCE DIMENSIONS

MODEL #	SLIM TRIM KIT MODELS WMT50011K / KMBT5011K		STANDARD TRIM KIT MODELS WMT55511K / KMBT5511K	
	in	cm	in	cm
Unit of Measurement				
Width of cabinet opening (min.)* (A)	30	76.2	30	76.2
Width of cutout (B)	28½	72.4	28½	72.4
Height of cutout (C)	12	30.5	17⅛	43.5
Top of cutout to bottom of upper cabinet door (min.) (D)	2	5.1	2	5.1
Bottom of cutout to top of lower cabinet door (min.) (E)	1 ⁹ / ₁₆	4	1 ⁹ / ₁₆	4
Depth of cutout (min.) (F)	21¾	55.2	21¾	55.2
Bottom of cutout to floor (min.) (G)	36	91.4	36	91.4
Back of the microwave oven to the surface of junction box (H)	4" (10.2 cm) < H < 40" (102 cm)			
Recommended junction box location (e)	Upper right quadrant			
Can this product be installed flush? Flush refers to the appliance not protruding past the cabinet depth. (Y/N) (J)	N			

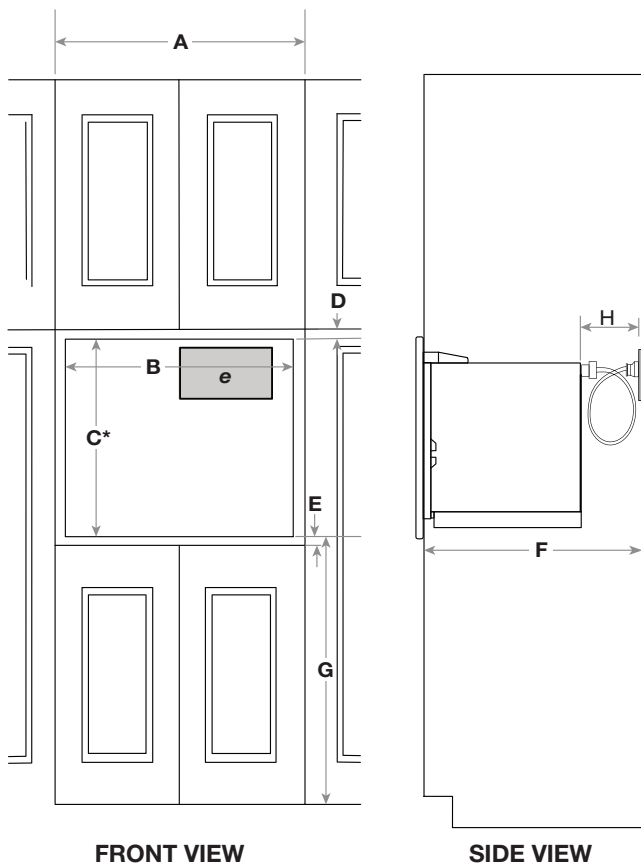

ELECTRICAL REQUIREMENTS

120 V, 60 Hz, AC only, 15 or 20 A fused, electrical supply is required. A time-delay fuse or dedicated circuit is recommended. Use a grounded 3 prong outlet. Do not use an extension cord.

LOCATION REQUIREMENTS

- This is a built-in appliance. Do not use as countertop microwave oven.
- Minimum of 36" from the floor to cut-out floor.
- Complete enclosure around the recessed portion of the microwave oven.
- This microwave oven must be installed into a wood cabinetry. The location must provide:
 1. Cutout opening that is plumb and square.
 2. Cutout floor that is solid, level and flush with bottom of cabinet cutout.
 3. Support for weight of at least 150 lbs (68 kg), which includes microwave oven and items placed inside.

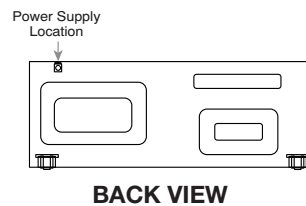

IMPORTANT: Dimensional specifications are provided for planning purposes only. **Do not make any cutouts based on this information.** Refer to the Installation Guide before selecting cabinetry, verifying electrical/gas connections, making cutouts or beginning installation. All Whirlpool® appliances are appropriately UL, CUL or CSA approved.

MICROONDAS EMPOTRABLE CON KITS DE MOLDURAS

DIMENSIONES DEL PRODUCTO

N.º DE MODELO	MODELOS CON KIT DE MOLDURAS DELGADAS		MODELOS CON KIT DE MOLDURAS ESTÁNDAR	
	WMT50011K/KMBT5011K		WMT55511K/KMBT5511K	
Unidad de medida	pulg.	cm	pulg.	cm
Ancho total del microondas (A)	27 ¹³ / ₁₆	70,7	27 ¹³ / ₁₆	70,7
Altura total del microondas (B)	10 ⁵ / ₁₆	26,2	10 ⁵ / ₁₆	26,2
Altura de la puerta (C)	10 ⁵ / ₁₆	26,2	10 ⁵ / ₁₆	26,2
Profundidad sin puerta (D)	16 ³ / ₈	41,6	16 ³ / ₈	41,6
Profundidad con puerta (E)	18	45,7	18	45,7
Profundidad con puerta abierta a 90° (F)	42 ¹ / ₈	107	42 ¹ / ₈	107
Distancia desde la pared fija a la puerta abierta a 90° (G)	1/2	1,3	1/2	1,3

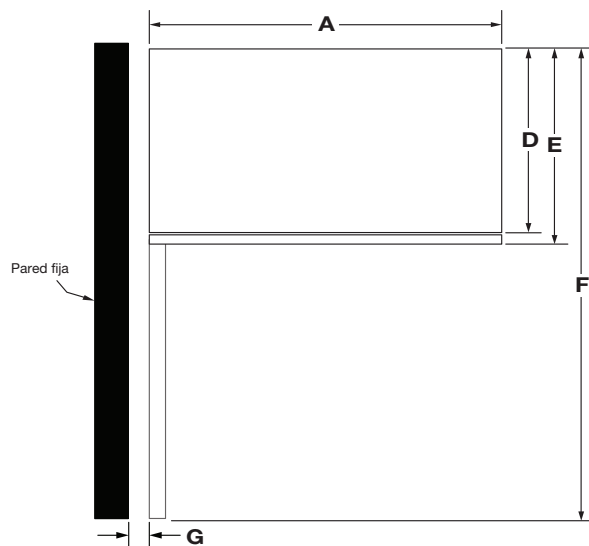
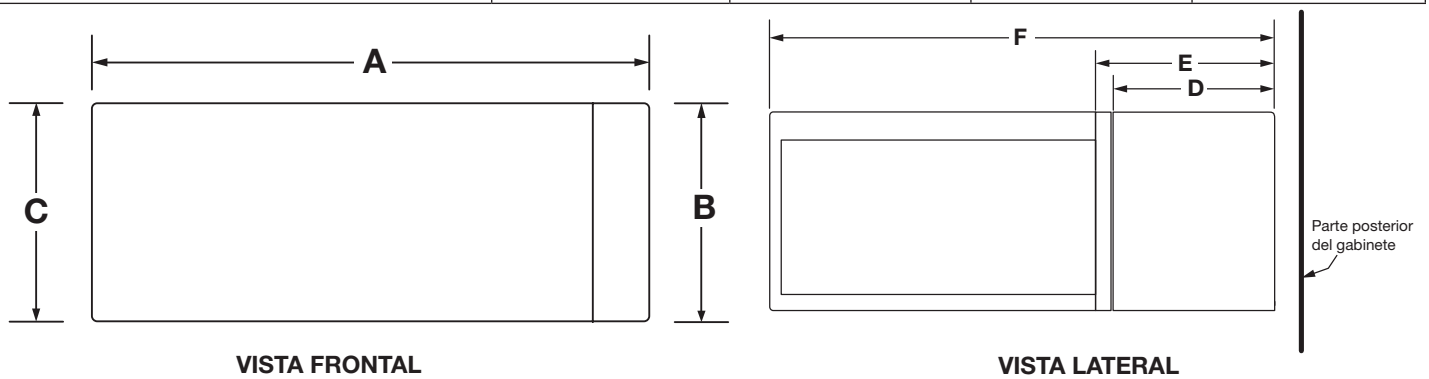

IMPORTANTE: Las especificaciones de medidas son solo para fines de planificación.
No realice ningún corte basado en esta información. Consulte la Guía de instalación antes de seleccionar gabinetes, verificar las conexiones eléctricas/de gas, realizar cortes o iniciar la instalación.
 Todos los electrodomésticos Whirlpool® poseen la homologación UL, CUL o CSA pertinente.

DIMENSIONES DEL MARCO DEL KIT DE MOLDURAS

N.º DE MODELO	MODELOS CON KIT DE MOLDURAS DELGADAS		MODELOS CON KIT DE MOLDURAS ESTÁNDAR	
	WMT50011K/KMBT5011K		WMT55511K/KMBT5511K	
Unidad de medida	pulg.	cm	pulg.	cm
Ancho total del marco del kit de molduras (H)	29 ³ / ₄	75,6	29 ³ / ₄	75,6
Altura total del marco del kit de molduras (J)	14	35,6	19 ¹ / ₈	48,6
Altura de la abertura interior del marco del kit de molduras (K)	10 ⁹ / ₁₆	26,9	10 ⁹ / ₁₆	26,9
Ancho de la abertura interior del kit de molduras (L)	28	71,1	28	71,1
Profundidad del marco del kit de molduras (M)	2 ⁵ / ₁₆	5,8	2 ⁵ / ₁₆	5,8
Espesor del marco del kit de molduras (visible) (N)	7/8	2,2	7/8	2,2

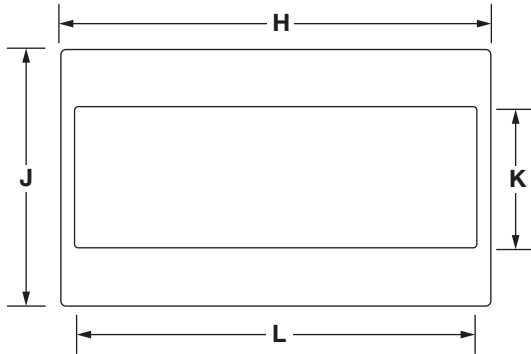

VISTA FRONTAL

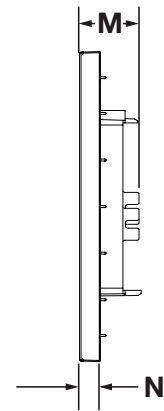

VISTA LATERAL

IMPORTANTE: Las especificaciones de medidas son solo para fines de planificación.
No realice ningún corte basado en esta información. Consulte la Guía de instalación antes de seleccionar gabinetes, verificar las conexiones eléctricas/de gas, realizar cortes o iniciar la instalación.
 Todos los electrodomésticos Whirlpool® poseen la homologación UL, CUL o CSA pertinente.

DIMENSIONES SEGÚN LA INSTALACIÓN

N.º DE MODELO	MODELOS CON KIT DE MOLDURAS DELGADAS		MODELOS CON KIT DE MOLDURAS ESTÁNDAR	
	WMT50011K/KMBT5011K		WMT55511K/KMBT5511K	
Medidas de la abertura/espacio	pulg.	cm	pulg.	cm
Altura de la puerta (A)	10 ⁵ / ₁₆	26,2	10 ⁵ / ₁₆	26,2
Altura total del marco del kit de molduras (B)	14	35,6	19 ¹ / ₈	48,6
Altura total del microondas (C)	10 ⁵ / ₁₆	26,2	10 ⁵ / ₁₆	26,2
Altura total con guía (D)	11 ³ / ₁₆	28,3	11 ³ / ₁₆	28,3
Profundidad con puerta (E)	18	45,7	18	45,7
Profundidad con puerta abierta a 90° (F)	42 ¹ / ₈	93,7	42 ¹ / ₈	93,7
Saliente del marco del kit de molduras (marco superior) (G)	1	2,6	1	2,6
Saliente del marco del kit de molduras (marco inferior) (H)	1	2,6	1	2,6
Ancho total del marco del kit de molduras (J)	29 ³ / ₄	75,6	29 ³ / ₄	75,6
Altura total del microondas (K)	10 ⁵ / ₁₆	26,2	10 ⁵ / ₁₆	26,2
Altura total del marco del kit de molduras (L)	14	35,6	19 ¹ / ₈	48,6
Saliente del marco del kit de molduras (marco izquierdo) (M)	5/8	1,6	5/8	1,6
Saliente del marco del kit de molduras (marco derecho) (N)	5/8	1,6	5/8	1,6
Distancia desde la pared fija a la puerta abierta a 90° (P)	1/2	1,3	1/2	1,3

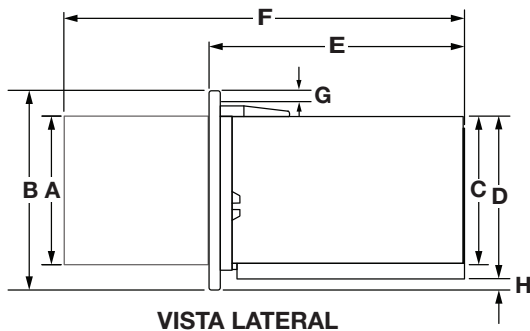

VISTA LATERAL

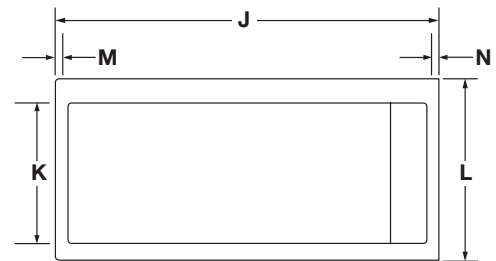

VISTA FRONTAL

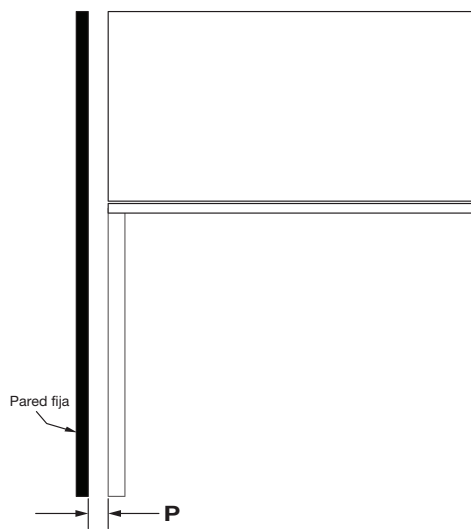

VISTA SUPERIOR

IMPORTANTE: Las especificaciones de medidas son solo para fines de planificación.

No realice ningún corte basado en esta información. Consulte la Guía de instalación antes de seleccionar gabinetes, verificar las conexiones eléctricas/de gas, realizar cortes o iniciar la instalación. Todos los electrodomésticos Whirlpool® poseen la homologación UL, CUL o CSA pertinente.

DIMENSIONES DE LA CAVIDAD INTERIOR DEL MICROONDAS

N.º DE MODELO	MODELOS CON KIT DE MOLDURAS DELGADAS		MODELOS CON KIT DE MOLDURAS ESTÁNDAR	
	WMT50011K/KMBT5011K		WMT55511K/KMBT5511K	
Unidad de medida	pulg.	cm	pulg.	cm
Altura de la cavidad (J)	7	17,7	7	17,7
Altura de la cavidad desde el punto más alto de la bandeja giratoria (K)	6 ⁷ / ₈	17,5	6 ⁷ / ₈	17,5
Ancho de la cavidad (L)	18 ⁷ / ₈	48	18 ⁷ / ₈	48
Profundidad de la cavidad (M)	14	35,6	14	35,6
Diámetro de la bandeja giratoria (N)	12	30,5	12	30,5

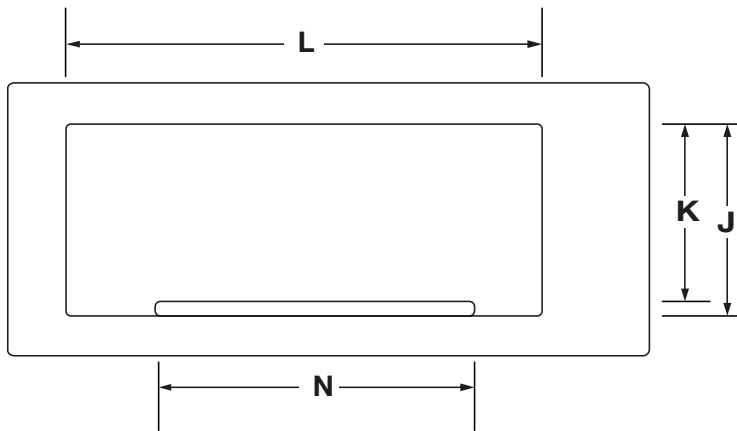

VISTA FRONTAL

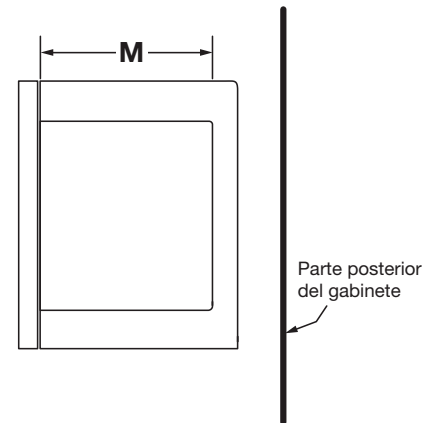

VISTA LATERAL

IMPORTANTE: Las especificaciones de medidas son solo para fines de planificación.
No realice ningún corte basado en esta información. Consulte la Guía de instalación antes de seleccionar gabinetes, verificar las conexiones eléctricas/de gas, realizar cortes o iniciar la instalación.
 Todos los electrodomésticos Whirlpool® poseen la homologación UL, CUL o CSA pertinente.

DIMENSIONES

MEDIDAS DE ABERTURA/ESPACIO

10 de 10

N.º DE MODELO	MODELOS CON KIT DE MOLDURAS DELGADAS		MODELOS CON KIT DE MOLDURAS ESTÁNDAR	
	WMT50011K/KMBT5011K		WMT55511K/KMBT5511K	
Unidad de medida	pulg.	cm	pulg.	cm
Ancho de la abertura del gabinete (mín.)* (A)	30	76,2	30	76,2
Ancho del recorte (B)	28 ^{1/2}	72,4	28 ^{1/2}	72,4
Altura del recorte (C)	12	30,5	17 ^{1/8}	43,5
Parte superior del recorte a la parte inferior de la puerta del gabinete superior (mín.) (D)	2	5,1	2	5,1
Parte inferior del recorte a la parte superior de la puerta del gabinete inferior (mín.) (E)	1 ^{9/16}	4	1 ^{9/16}	4
Profundidad del recorte (mín.) (F)	21 ^{3/4}	55,2	21 ^{3/4}	55,2
Parte inferior del recorte al piso (mín.) (G)	36	91,4	36	91,4
Parte trasera del horno de microondas a la superficie de la caja de conexiones (H)	4" (10,2 cm) < H < 40" (102 cm)			
Ubicación recomendada para la caja de conexiones (e)	Cuadrante superior derecho			
¿Este producto se puede instalar al ras? Al ras significa que el electrodoméstico no sobresale del gabinete. (S/N) (J)	N			

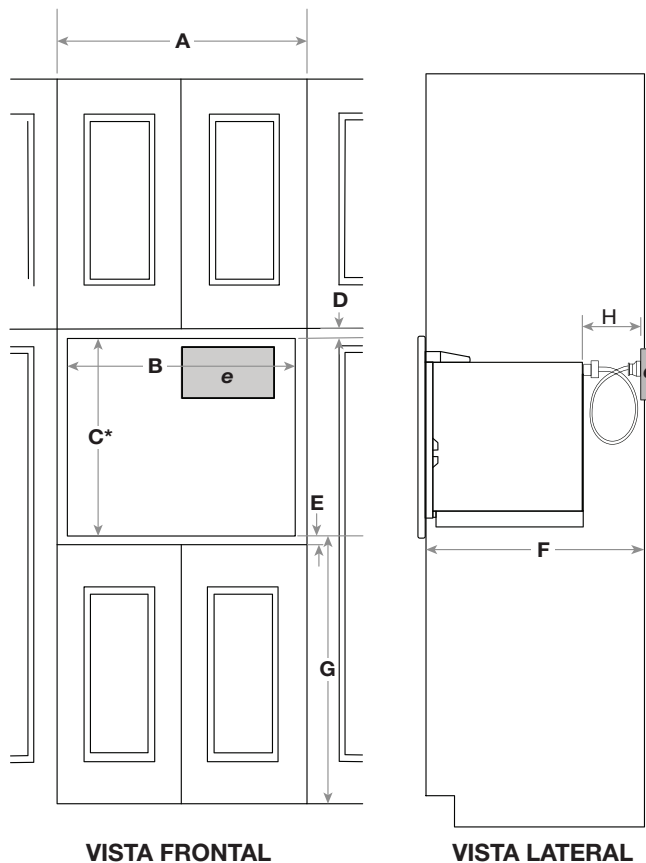

REQUISITOS ELÉCTRICOS

Se requiere un suministro eléctrico de 120 V, 60 Hz, CA solamente, con fusibles de 15 A o 20 A. Se recomienda un fusible retardador o un disyuntor dedicado. Use un tomacorriente de 3 terminales con conexión a tierra. No use un cable de extensión.

REQUISITOS DE UBICACIÓN

- Este es un electrodoméstico empotrable. No lo use como horno de microondas para mostrador.
- Un mínimo de 36" (91,4 cm) desde el piso hasta la base de recorte.
- Un recinto completamente cerrado alrededor de la parte empotrada del horno de microondas.
- Este horno de microondas debe instalarse en un gabinete de madera. La ubicación debe tener:
 1. Una abertura de recorte que esté a plomo y a escuadra.
 2. Una base de recorte que sea sólida, esté nivelada y al ras con el recorte inferior del gabinete.
 3. Un soporte de peso para 150 lb (68 kg) por lo menos, lo que incluye el horno de microondas y los artículos que se coloquen dentro de él.

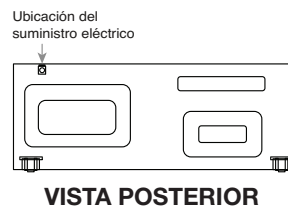

IMPORTANTE: Las especificaciones de medidas son solo para fines de planificación. **No realice ningún corte basado en esta información.** Consulte la Guía de instalación antes de seleccionar gabinetes, verificar las conexiones eléctricas/de gas, realizar cortes o iniciar la instalación. Todos los electrodomésticos Whirlpool® poseen la homologación UL, CUL o CSA pertinente.