



**FOR USER**  
**THIS RANGE IS FOR RESIDENTIAL USE ONLY**  
**INSTALLATION AND SERVICE MUST BE PERFORMED BY A**  
**QUALIFIED INSTALLER.**



Dear Customer,  
Thank you for choosing Lofra appliances. We are pleased to welcome you as a new customer.  
The safety precautions and recommendations reported below are for yours and other People's safety, and they will also help you to make full use your appliance.

Please keep this booklet safe, it will be useful in the future for reference.

This appliance must be used only for the function for which it was designed, i.e. to cook food.  
Any other use shall be considered inappropriate or dangerous.

The manufacturer will not be responsible in case of improper use of the appliance.

**WARNING:**

**This appliance has to be installed by a qualified installer. Improper installation, adjustment, alteration, services, or maintenance can cause injury or property damage. Consult a qualified installer, service agent, or the gas supplier.**

**WARNING:**

- This range can tip. Injury to person could result.
- Install anti-tip device shipped with range.
- See installation Instructions.

**IMPORTANT: SAVE FOR LOCAL ELECTRICAL INSPECTOR'S USE.****READ AND SAVE THESE INSTRUCTIONS FOR FUTURE REFERENCE.****OBSERVE ALL GOVERNING CODES AND ORDINANCES.****WARNING: If the information in this manual is not followed exactly, a fire or explosion may result causing property damage, personal injury or death.****Do not store or use gasoline or other flammable vapors and liquids in the vicinity of this or any other appliance.****WHAT TO DO IF YOU SMELL GAS**

- Do not light any appliance.
- Do not touch any electrical switch.
- Do not use any phone in your building.
- Immediately call your gas supplier from a neighbour's phone. Follow the gas supplier's instructions.
- If you cannot reach your gas suppliers, call the fire department.

**Installation and service must be performed by a qualified installer service agency or the gas supplier.****WARNING:****A child or adult can tip the range and be killed.****Verify the anti-tip device has been properly installed and engaged****Ensure the anti-tip device is re-engaged when the range is moved.****Do not operate the range without the anti-tip device in place and engaged.****Failure to do so can result in death or serious burns to children or adults.****CHECKING THE ANTI TIP DEVICE**

To check the installation of the anti-tipping safety system, we recommend that you view the installation of the bracket under the kitchen (in the visible part between the feet, see illustration).

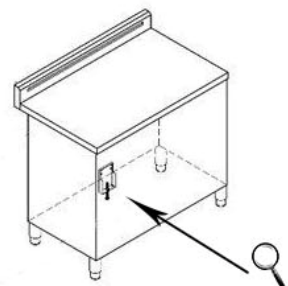

## **IMPORTANT - PLEASE READ AND FOLLOW**

- Before beginning, please read these instructions completely and carefully.
- Do not remove permanently affixed labels, warnings, or plates from the product. This may void the warranty
- Please observe all local and national codes and ordinances.
- Please ensure that this product is properly grounded.
- The installer should leave these instructions with the consumer who should retain for local inspector's use and for future reference.

**For an installation at altitudes above 2000 ft (610 mt) contact the Service Centre.**

## **IMPORTANT INSTRUCTION**

- ***Proper installation – Be sure your appliance is properly installed and grounded by a qualifier technician.***
- ***Never Use Your Appliance for Warming or Heating the Room.***
- ***Do Not Leave Children Alone – Children should not be left alone or unattended in area where appliance is in use. They should never be allowed to sit or stand on any part of the appliance.***
- ***Wear Proper Apparel – Loose-fitting or hanging garments should never be worn while using the appliance.***
- ***User Servicing – Do not repair or replace any part of the appliance unless specifically recommended in the manual. All other servicing should be referred to a qualified technician.***
- ***Storage in or on Appliance – Flammable materials should not be stored in an oven or near surface units.***
- ***Do Not Use Water on Grease Fires – Smother fire or flame or use dry chemical or foam-type extinguisher.***
- ***Use Only Dry Potholders – Moist or damp potholders on hot surfaces may result in burns from steam. Do not let potholder touch hot heating elements. Do not use a towel or other bulky cloth.***
- ***Use Care When Opening Door – Let hot air or steam escape before removing or replacing food.***
- ***Do Not Heat Unopened Food Containers – Build-up of pressure may cause container to burst and result in injury.***
- ***Keep Oven Vent Ducts Unobstructed.***

- ***Placement of Oven Racks – Always place oven racks in desired location while oven is cool. If rack must be moved while oven is hot, do not let potholder contact hot heating element in oven.***
- ***To check the installation of the anti-tipping safety system, we recommend that you view the installation of the bracket under the kitchen (in the visible part between the feet, see illustration).***
- ***Installation must conform with local codes or in the absence of codes, the National Fuel Gas Code ANSIZ223.1/NFPA 54- latest edition. Electrical installation must be in accordance with the National Electrical Code, ANSI/NFPA70 - latest edition and/or local codes.***

**The instructions have been examined by the testing agency for comprehensibility, accuracy and compatibility with the results of tests.**

### **IN CANADA:**

**The installation must conform with local codes or, in the absence of local codes, with the Natural Gas Propane Installation Code, CSA B149.1.**

## **GENERAL INFORMATION**

---

### **WARNING!!**

1. This appliance shall not be used for space heating. This information is based on safety considerations.
2. All openings in the wall behind the appliance and in the floor under the appliance shall be sealed.
3. Keep appliance area clear and free from combustible materials, gasoline, and other flammable vapors.
4. Do not obstruct the flow of combustion and ventilation air.
5. Disconnect the electrical supply to the appliance before servicing.
6. When removing appliance for cleaning and/or service:
  - Shut off gas at main supply.
  - Disconnect AC power supply.
  - Disconnect gas line to the inlet pipe.
  - Carefully remove the range by pulling outward.

**CAUTION:** Range is heavy; use care in handling.

7. **Electrical Requirement:** electrical installation should comply with national and local codes.
8. **Air Supply and Ventilation:** the installer must refer to local/national codes. The appliance should not be installed with a ventilation system that blows air downward toward the appliance. This type of ventilation system may cause ignition and combustion problems with the gas cooking appliance resulting in personal injury or unintended operation. An air curtain or other overhead range hood, which operates by blowing a downward airflow onto a range, shall not be used in conjunction with a range.
9. **Gas Manifold Pressure:**
- natural gas - 5.0" W.C.P.
  - Propane - 10.0" W.C.P.
10. The misuse of oven door (e.g. stepping, sitting, or leaning on them) can result in potential hazards and/or injuries.
11. When installing or removing the range for service, a rolling lift jack should be used. Do not push against any of the edges of the range in an attempt to slide it into or out of the installation. Pushing or pulling a range (rather than using a lift jack) also increases the possibility of bending the leg spindles or the internal coupling connectors.

**WARNING:**

**ELECTRICAL GROUNDING INSTRUCTIONS**

**The range must be electrically grounded in accordance with local codes or, in the absence of local codes, with the National Electrical Code, NFPA 70 or the Canadian Electric Code, CSA C22.1-02. Installation should be made by a licensed electrician.**

**FOR PERSONAL SAFETY, THIS APPLIANCE MUST BE PROPERLY GROUNDED.**

---

## **REPLACEMENT PARTS**

Only authorized replacement parts may be used in performing service on the range. Replacement parts are available from factory authorized parts distributors. Contact the nearest parts distributor in your area.

# PRODUCT SPECIFICATION

---

## IMPORTANT NOTE TO THE CONSUMER

Keep these instructions manual for future reference.

- As when using any appliance generating heat, there are certain safety precautions you should follow.
- Be sure your cooktop is installed and grounded properly by a qualified installer or service technician.
- Make sure the wall covering around the cooktop can withstand the heat generated by the cooktop.

Write the appliance's model/serial numbers in this manual for service/maintenance reference.

The user have to keep this manual for personal reference and for that of inspectors, service personnel, etc.



### **CAUTION:**

Cold temperature can damage the electronic control. When using the appliance for the first time, or when the appliance has not been used for an extended period, be certain the unit has been in temperatures above 32°F (0°C) for at least 3 hours before turning on the power to the appliance.

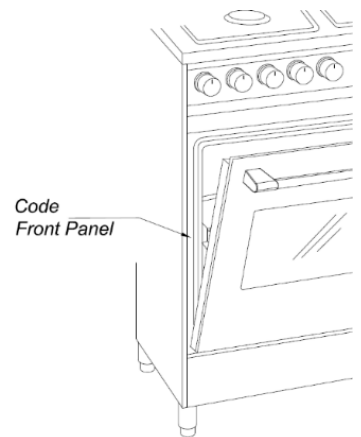

## CUSTOMER SERVICE INFORMATION

The serial number can be found on the inner side of door trim.

## IMPORTANT SAFETY INSTRUCTIONS

---

- ✓ The manufacturer declines all liability for injury to persons or damage to property caused by incorrect or improper use of the appliance.
- ✓ After having unpacked the appliance, check to ensure that it is not damaged.
- ✓ This range is supplied with a protective film on steel and aluminium parts. This film must be removed before installing/using the appliance.
- ✓ This appliance is intended for use in your household. Never use the appliance for any other purpose!
- ✓ In case of doubt, do not use the appliance and consult your supplier or a professionally qualified technician.

- ✓ Do not attempt to modify the technical characteristics of the appliance as this may become dangerous to use.
- ✓ Do not carry out cleaning or maintenance operations on the appliance without having previously disconnected it from the electric power supply.
- ✓ After use, ensure that the knobs are in OFF position.
- ✓ Do not allow children or other incapable people to use the appliance without supervision.
- ✓ Keep children away from the range when it is in use.
- ✓ Do not cook on broken cook-top: if cook-top should break, cleaning solutions and spillovers may penetrate the broken cook – top and create a risk of electric shock. Contact a qualified technician immediately.
- ✓ Clean cook – top with caution: if a wet sponge or cloth is used to wipe spills on a hot cooking area, be careful to avoid steam burn. Some cleaners can produce noxious fumes if applied to a hot surface.
- ✓ Induction cooktop surface units: do not place metallic objects such as knives, forks, spoons and lids on the cooktop surface since they can get hot.
- ✓ Do not touch heating elements or interior surfaces of oven: heating elements may be hot even though they are dark in colour. Interior surfaces of an oven become hot enough to cause burns. During and after use of the range, do not touch, or let clothing or other flammable materials contact heating elements or interior surfaces of oven until they have had sufficient time to cool.
- ✓ Placement of oven racks: always place oven racks in desired location while oven is cool. If rack must be moved while oven is hot, do not let potholder contact hot heating element in oven.
- ✓ Fire risk! Do not store flammable material in the oven, and in the storage compartment.
- ✓ All the non-combustible material is to be installed on the underside of a cabinet located above the broiler section or unit in accordance with local codes, or in absence of local codes, with the National Fuel Gas Code, ANSI Z223.1/NFPA 54 or, in Canada, the Natural Gas and Propane Installation Codes, CSA B149.1.
- ✓ Make sure that electrical cables connecting other appliances in the proximity of the range cannot come into contact with the hob or become entrapped in the oven door.
- ✓ Do not line the oven walls with aluminium foil. Do not place shelves, broiler pan, pans or other cooking utensils on the base of the oven chamber.
- ✓ Never cover any slots, holes or passages in the oven bottom or cover an entire rack with materials such as aluminium foil. Doing so blocks air flow through the oven and may cause

carbon monoxide poisoning. Aluminium foil linings may also trap heat, causing a fire hazard.

- ✓ To avoid any possible hazard, the appliance must be installed by qualified personnel only. Any repairs by unqualified persons may result in electric shock or short circuit. In order to avoid possible injuries to your body or to the appliance, do not attempt any repairs by yourself. Such work should be carried out by qualified service personnel only.
- ✓ Danger of burns! The oven and cooking accessories may become very hot during operation. Make sure children are kept out of reach and warn them accordingly. To avoid burns use kitchen clothes and gloves when handling hot parts or utensils.
- ✓ Stand away from the range when opening oven door. Hot air or steam which escapes can cause burns to hands, face, and/or eyes.
- ✓ Remove the door and the storage compartment pivoting panel before disposal to prevent entrapment.
- ✓ Never clean the range, oven and storage compartment with a high-pressure steam cleaning device, as it may provoke a short circuit.
- ✓ Wear Proper Apparel: loose – fitting or hanging garments should never be worn while using the appliance.
- ✓ Packing elements (i.e. plastic bags, polystyrene foam, nails, packing straps, etc.) should not be left around within easy reach of children, as these may cause serious injuries.
- ✓ The packaging material is recyclable and is marked with the recycling symbol .
- ✓ If you should decide not to use this appliance any longer (or decide to substitute an older model), before disposing of it, it is recommended that it be made inoperative in an appropriate manner in accordance to health and environmental protection regulations, ensuring in particular that all potentially hazardous parts be made harmless, especially in relation to children who could play with old appliances.
- ✓ The appliance should not be installed with a ventilation system that blows air downward toward the appliance. This type of ventilation system may cause ignition and combustion problems with the gas cooking appliance resulting in personal injury or unintended operation.
- ✓ An air curtain or other overhead range hood, which operates by blowing a downward airflow onto a range, shall not be used in conjunction with a range.



## IMPORTANT PRECAUTIONS AND RECOMMENDATIONS FOR USE OF ELECTRICAL APPLIANCES

Use of any electrical appliance implies the necessity to follow a series of fundamental rules. In particular:

- ✓ Never touch the appliance with wet hands or feet;
- ✓ Do not operate the appliance barefooted;
- ✓ Do not allow children or disabled people to use the appliance without your supervision.

### **WARNING:**

**NEVER use this appliance as a space heater to heat or warm the room. Doing so may result in carbon monoxide poisoning and overheating of the oven.**

## FIRE SAFETY

- Do not store/place/use combustible materials (e.g., paper, plastic, pot holders, linens, gasoline, alcohol) near the product.
- Do not douse a grease fire with water. Instead, turn off the heat source, and smother the fire with a tight-fitting lid, or use a multi-purpose, dry-chemical or foam extinguisher.
- If a grease fire should occur in the oven, turn off the oven by putting the handle in the OFF position.
- Do not wear loose fitting or hanging garments while using the product.
- Use only dry potholders: moist or damp potholders on hot surfaces may result in burns from steam. Do not let potholder touch hot heating elements. Do not use a towel or other bulky cloth.
- Do not let potholders or other flammable material touch a heating element. Do not use a towel or other bulky cloth item as a pot holder.
- Use proper pan size: this appliance is equipped with one or more surface units of different size. Select pans having flat bottoms large enough to cover the surface unit-heating element. The use of undersized utensils will expose a portion of the heating element to direct contact and may result in ignition of clothing. Proper relationship of utensil to burner will also improve efficiency.

- Glazed cooking utensils: only certain types of glass, glass/ceramic, ceramic, earthenware, or other glazed utensils are suitable for range-top service without breaking due to the sudden change in temperature.
- Never leave surface units unattended at high heat settings: broilover causes smoking and greasy spillovers that may ignite.
- Do not soak removable heating elements: heating elements should never be immersed in water.
- Keep oven vent ducts unobstructed, to avoid grease build up, regularly clean the vents.
- Use care when opening door: let hot air or steam escape before removing or replacing food.
- Keep the oven door closed until the fire goes out. If necessary, use a multipurpose dry chemical or foam-type fire extinguisher.
- Do not heat unopened food containers: build-up of pressure may cause container to burst and result in injury.

## **GAS SAFETY**

If you smell gas:

- Close the valve and do not use the product.
- Do not light a match, candle, or cigarette.
- Do not turn on any gas or electric appliances.
- Do not touch any electrical switch or plug in a power cord.
- Do not use any phone in your building.
- Evacuate everyone from the building.
- Immediately call your gas supplier from a neighbor's phone. Follow the gas supplier's instructions.
- If you cannot reach your gas supplier, call the fire department.
- Checking for gas leaks.
- Leak-testing the appliance must be done according to the manufacturer's instructions. Do not use a flame to check for gas leaks. Use a brush to spread a soap-and-water solution around the area you are checking. If there is a gas leak, small bubbles will appear in the solution. When not sure, call for professional help.

## **ELECTRICAL AND GROUNDING SAFETY**

- Do not use an adapter or an extension cord.
- Do not use a damaged power plug, power cord, or loose power outlet.
- Do not modify the power plug, cord, or outlet.
- Do not put a fuse in a neutral or ground circuit.
- Do not connect the ground wire to plastic plumbing lines, gas lines, or hot water pipes.
- This product must be grounded. If the range malfunctions or breaks down, grounding reduces the risk of electric shock by providing a safe path for the current. This range's power cord has a grounding plug, which must be firmly plugged into an outlet that is properly installed and grounded according to local regulations. If you are not sure your electrical outlet is properly grounded, have it checked by a licensed electrician.
- The range is supplied with a 4-pronged grounded plug. This cord must be plugged into a mating, grounded 4-prong outlet that meets all local codes and ordinances.
- The product owner shall ensure that the proper electrical service is provided for the product.

## **COOKTOP SAFETY**

- Before igniting, make sure all burner caps are properly in place and all burners are level.
- Make sure all burners are OFF when not in use.
- Do not leave burners unattended on medium or high heat settings.
- When you set a burner to simmer, do not turn the knob quickly. Make sure the flame stays on.
- If ignition fails, turn the knob to OFF, and wait 5 minutes for the gas to dissipate.
- Do not place any objects other than cookware on the cooktop.
- Before removing or changing cookware, turn off the burners.
- Remove food and cookware immediately after cooking.
- Make sure all cooktop burners are off and all surfaces have completely cooled before removing the grates and disassembling the burners.

- Before self-cleaning the oven: remove broiler pan and other utensils.
- After cleaning the burner head, make sure it is completely dry before re-assembling.
- To avoid carbon monoxide poisoning, do not pour water or other liquids into the cooktop during cleaning.
- Do not clean door gasket: the door gasket is essential for a good seal. Care should be taken not to rub, damage, or move the gasket.
- Do not use oven cleaners: no commercial oven cleaner or oven liner protective coating of any kind should be used in or around any part of the oven.
- Clean only parts listed in manual.
- Select cookware that is designed for cooktops and that is large enough to cover the grates. Burner flames should not extend beyond the bottom of the cookware.
- To avoid cookware discoloration, deformity, and/or carbon monoxide poisoning, do not use cookware that is exceedingly larger than the grate.
- Do not use aluminium foil to line the grates or any part of the cooktop.
- Always use a minimum amount of oil for any type of frying. Always thaw food before frying, and do not fry food that is overly cold or that has clumps of ice attached to it.
- When frying, always heat the oil slowly, and monitor the oil as it heats. When frying foods at high heat, monitor the oil throughout the cooking process. If combining fats or oils for frying, mix them together before heating. Stand at a safe distance while frying to avoid hot spatter.
- Use a deep-fry thermometer when possible to avoid heating the oil beyond its smoke point. (Know the smoke point of the oil you are using.)
- Always let the oil/fat in the cookware to cool to room temperature before moving the cookware.
- To avoid delayed-eruptive boiling, let hot oil/fat stand at least 20 seconds after turning off the burner so the temperature can stabilize. In the event of scalding, follow these first-aid instructions:
  1. Immerse the scalded area in cool or lukewarm water for at least 10 minutes.
  2. Do not apply any creams, oils, or lotions.
  3. Cover with a clean, dry cloth.

## OVEN SAFETY

- Do not use the oven for non-cooking purposes such as drying clothes or storage. Use the oven for cooking purposes only.
- Do not leave plastic items inside the oven.
- Do not use aluminium foil or foil liners anywhere in the oven. Do not use aluminium foil or like material to cover any holes or passages in the oven bottom or to cover an oven rack.
- When repositioning the oven racks, make sure the oven is completely cool.
- Make sure the oven racks are placed on the same level on each side.
- Do not damage, move, or clean the door gasket.
- Stand away from the oven when opening the oven door.
- To avoid damaging the burner control knobs or oven control, always bake and/or broil with the oven door closed.
- Do not broil meat too close to the broil element. Trim excess fat from meat before cooking.
- When using cooking or roasting bags in the oven, follow the manufacturer's directions.
- Keep the oven free from grease build up.
- Do not spray water on the oven glass while the oven is on or just after you have turned it off.
- Do not use harsh abrasive cleaners or sharp metal scrapers to clean the oven door glass. They can scratch the surface which may result in the glass shattering.



### **CAUTION:**

- Do not attempt to operate the oven during a power failure.
- If the power fails, always turn the oven off. If the oven is not turned off and the power returns, the oven may begin to operate again. Food left unattended could catch fire or spoil.

**WARNING:**

**Never leave children alone or unattended in the area where an appliance is in use. As children grow, teach them the proper, safe use of all appliances. Never leave the oven door open when the range is unattended.**



**CAUTION:**

- Stepping, leaning or sitting on the door or drawers of this range can result in serious injuries and can also cause damage to the range. A child or adult can tip the range and be killed.
- Do not store items of interest to children in the cabinets above the range. Children could be seriously burned climbing on the range to reach items.
- Do not store or use gasoline or other flammable vapors and liquids near this or any other appliance. Explosions or fires could result.
- To eliminate the need to reach over the surface burners, cabinet storage space above the burners should be avoided.
- Adjust surface burner flame size so it does not extend beyond the edge of the cooking utensil. Excessive flame is hazardous.
- Do not use the oven as a storage space. This creates a potentially hazardous situation.
- Install the anti - tip device to the structure and/or the range. Verify the anti - tip device has been properly installed and engaged.
- Re - engaged the anti - tip device if the range is moved. Do not operate the range without the anti - tip device in place and engaged.
- Never use your range for warming or heating the room. Prolonged use of the range without adequate ventilation can be dangerous.
- In the event of an electrical power outage, the surface burners can be lit manually. to light a surface burner, hold a lit match to the burner head and slowly turn the Surface Control knob to LITE. Use caution when lighting surface burners manually.
  - Reset all control to the "off" position after using a programmable timing operation.

**To avoid breakage:** Do NOT handle or manipulate the unit by the cooktop.

Electrical and gas equipment with moving parts can be dangerous. The important safety instructions in this manual are intended to minimize the risk of property damage, personal injury, and death. Be sure to read them.

Keep this manual in a handy place so you can refer to it as needed.

## REPLACEMENT PARTS

---

Only authorized replacement parts may be used in performing service on the range. Replacement parts are available from factory authorized parts distributors. Contact the nearest parts distributor in your area.

## PRODUCT SPECIFICATION

---

**NOTE: do not pinch the power supply cord or the flexible gas conduit between the range and the wall.**  
**Do not seal the range to the side cabinets.**

For all other information about the appliance, see the labels on the back of the appliance.

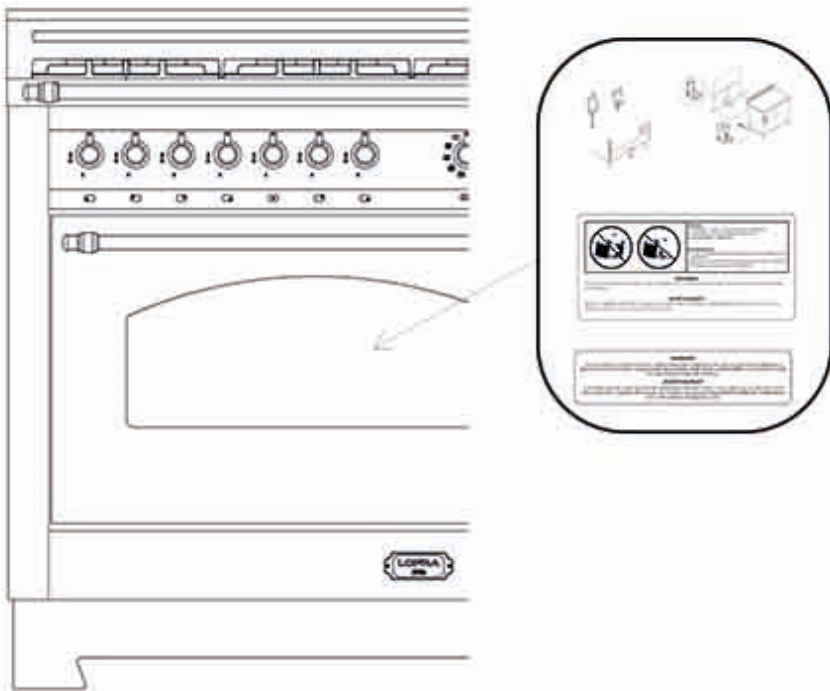

## PRODUCT SPECIFICATION

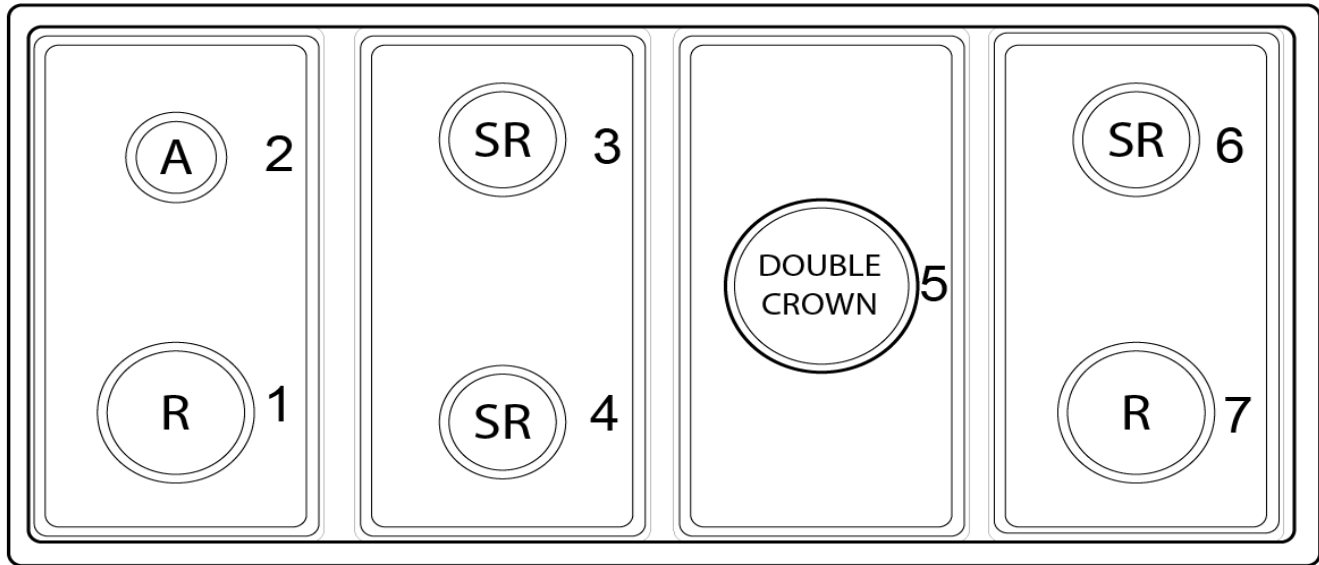

The cooking surface:

1. Front Left – Rapid (R)
2. Rear Left – Auxiliary (A)
3. Central Front Left - Semi-Rapid (SR)
4. Central Rear Left - Semi-Rapid (SR)
5. Central Right – Double Crown (DC)
6. Rear Right – Semi-Rapid (SR)
7. Front Right – Rapid (R)

### **Note:**

The electric gas-lighting device is incorporated into the knobs.

The appliance has a safety valve system fitted, the flow of gas will be stopped if and when the flame should accidentally go out.



### **CAUTION:**

**If the burner is accidentally extinguished, turn the gas off at the control knob and wait at least 1 minute before attempting to relight.**



### **CAUTION:**

**Gas appliances produce heat and humidity in the environment in which they are installed.**

**Ensure that the cooking area is well ventilated following national/local codes.**





## Controls description:

1. Front left burner control knob
2. Rear left burner control knob
3. Central rear left burner control knob
4. Central front left burner control knob
5. Central burner control knob
6. Rear right burner control knob
7. Front right burner control knob
8. Multifunction main oven switch knob
9. Multifunction main oven thermostat knob
10. Electronic programmer
11. Multifunction side oven timer knob
12. Multifunction side oven switch knob
13. Multifunction side oven thermostat knob

### **WARNING:**

**If overhead cabinets are provided, a range hood should also be provided that projects horizontally a minimum of 5 in (12.7 cm) beyond the front of the cabinets.**

**This will dissipate any heat build-up in the overhead cabinets to prevent death, personal injury, and/or fire hazard.**

**The ventilating hood must be constructed of sheet metal not less than 0.0122" thick. Install above the range with a clearance of not less than 1/4" between the hood and the underside of the combustible material or metal cabinet. The hood must be at least as wide as the appliance and centred over the appliance. Clearance between the cooking surface and the ventilation hood surface must never be less than 24 inches.**

# USING THE TOP BURNERS

## GAS BURNERS

Electronic ignition integrated in the knob: turn the knob to the maximum position and press it fully and the burner ignites automatically.

● No gas supply (tap closed)



Maximum gas supply



Minimum gas supply

To obtain the minimum flow rate, turn the knob counterclockwise and position the index finger of the knob at the small flame.

Safety device: once the burner is ignited, keep the knob pressed for at least 5 ÷ 10 seconds and then release, the burner remains ignited by the thermocouple (A), which keeps the gas passage open through a safety valve, which in case of accidental burner shutdown interrupts the gas passage.

In the event of a momentary power failure, the hob burner can be ignited manually using an igniter.

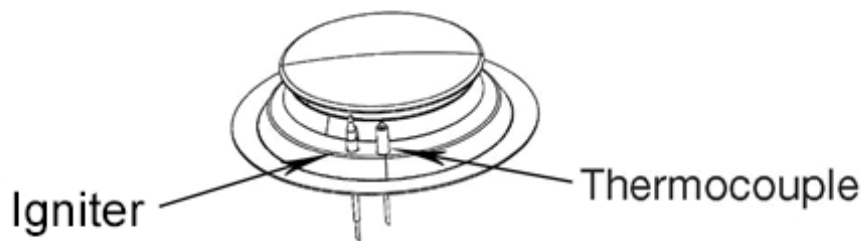
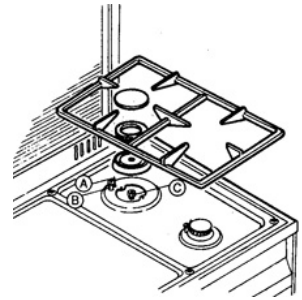

Push and turn the knob to the maximum gas position to induce a flame into the desired burner.

In the event of accidental extinction of the flame, it is advisable to turn the knob to the off position.

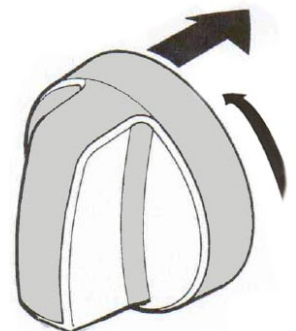

## BURNER PERFORMANCE

A variety of pans with a minimum diameter of 5 inches (12 cm) can be used on the “medium and small” burners. The pans must not have concave or convex bottoms, but be perfectly flat as shows in figure. For optimum performance, use the saucepans shown in figure, i.e. the flames must not stay beyond the bottom of the pan. When a liquid starts boiling, lower the flame as much as possible, but keep it on the boil. For safety reasons, we recommend using pans with the following diameters on the various burners (see tables).

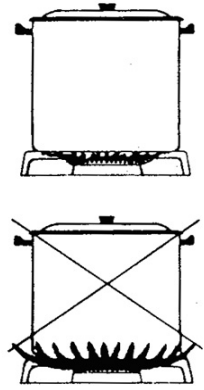

### CAUTION:

For emergency reasons we advise I use it of the following pots with diameters to overlap to the burners: auxiliary, semi-rapid, rapid, triple ring, fish burner.

Burner	Diameter min.		Diameter max	
	Inches	cm	Inches	cm
Small (auxiliary)	4	10	6	14
Medium (semi -rapid)	6	15	8	20
Large (rapid)	8	21	10	26
Triple ring (ultra-rapid) dual Ø125mm AEO	9	24	10	26
Dual Ø145mm AEO four-leaf	10	26	12	30

### NOTE:

A minimum 4 inches (10 cm) distance is recommended between the edges of two different pans.

## DISASSEMBLED AND REASSEMBLED GAS BURNERS

The burners can be disassembled and reassembled following the sequence in the picture for cleaning and maintenance.

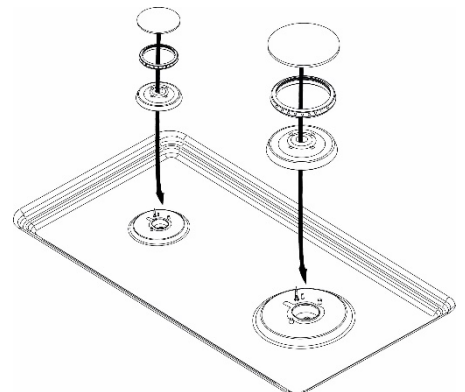

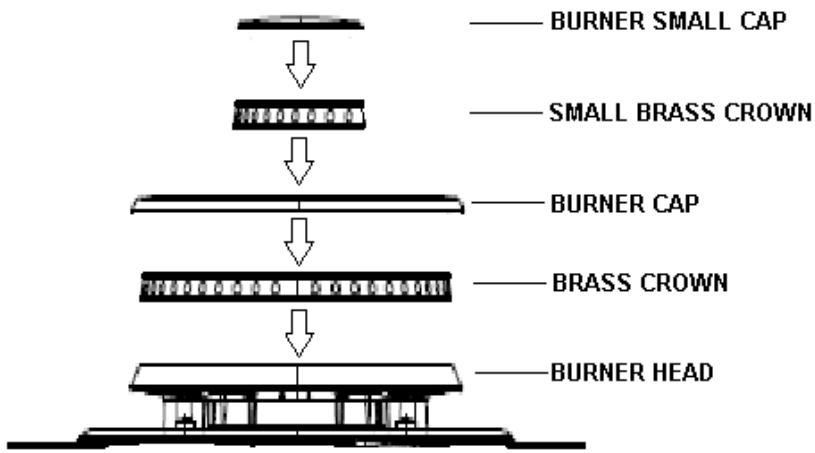

**Assembly of the burner caps and burner grates**

It is very important to make sure that all of the surface burner caps and surface burner grates are installed correctly and at the correct locations.

Once in place, you may check the fit by gently sliding the burner cap from side to side to be sure it is centered and firmly seated. When the burner cap lip makes contact inside the center of the burner head you will be able to hear the burner cap click.

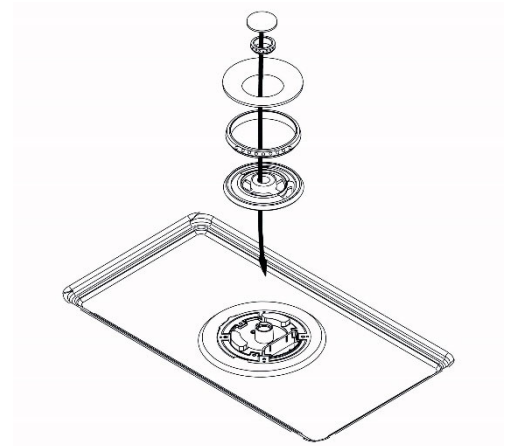

**Dual Burner**

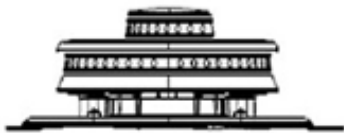

Correct Position

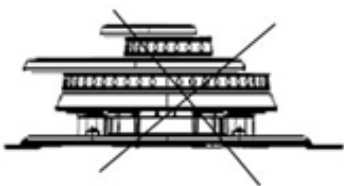

Incorrect Position

**Burner**

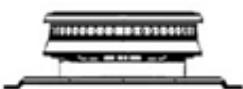

Correct Position

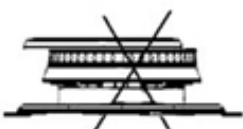

Incorrect Position

## INJECTORS TABLE – MAXIMUM INLET PRESSURE TO THE REGULATOR

BURNERS	NOMINAL POWER BTU/hr	NATURAL GAS (A)		PROPANE (E)	
		5" (12.7cm) (12.5mbar)		10" (25.4cm) (25mbar)	
		<i>min line pressure (i.w.c.)</i> <i>min pression de ligne (i.w.c.)</i>		<i>min line pressure (i.w.c.)</i> <i>min pression de ligne (i.w.c.)</i>	
		6" (15.2cm) (15mbar)		11" (27.9cm) (27.4mbar)	
		<i>max line pressure (i.w.c.)</i> <i>max pression de ligne (i.w.c.)</i>		<i>max line pressure (i.w.c.)</i> <i>max pression de ligne (i.w.c.)</i>	
		14" (35.6cm) (34.9mbar)		14" (35.6cm) (34.96mbar)	
		Ø injector (1/100 mm)		Ø injector (1/100 mm)	
Auxiliary	4000	90		60	
Semi-rapid (SR)	7000	120		78	
Rapid (R)	11000	150		96	
Dual (D)	16000	80/165		50/105	

## REGULATING THE MINIMUM OUTPUT OF THE COOKTOP BURNERS

Normal/valve taps

Ignite the burners and turn the knob to the maximum position. Remove the knob and insert a small flat-head screwdriver into the holes on the side of the control panel, in accordance with the type.

Loosen the by-pass screw by two turns in an anti-clockwise direction and rotate the rod to the minimum position.

Adjust the previously loosened screws until the flame is lowered but stable, even when rapid changes are made from the maximum to the minimum position with the burner cold. If safety taps are fitted, let the burner run on minimum for a few minutes to ensure that the device does not cut in. If does, increase the minimum.

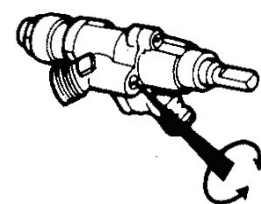

**N.B.:** for propane gas settings, the burner minimum must be set by fully tightening the tap by-passes.

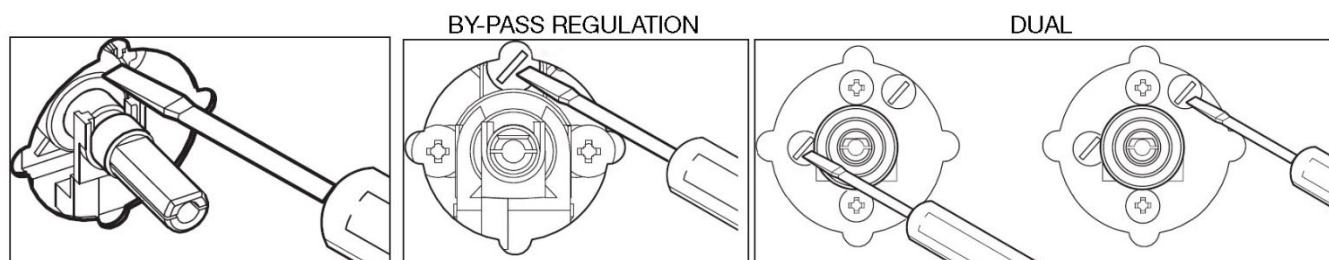

## OPERATIONS TO BE PERFORMED WHEN SUBSTITUTING THE INJECTORS

- ✓ Remove the gratings and the burner covers:
- ✓ Using a wrench substitute the nozzle injector with those most suitable for the kind of gas for which it is to be used.

The burners are conceived in such a way so as not to require the regulation of the primary air.

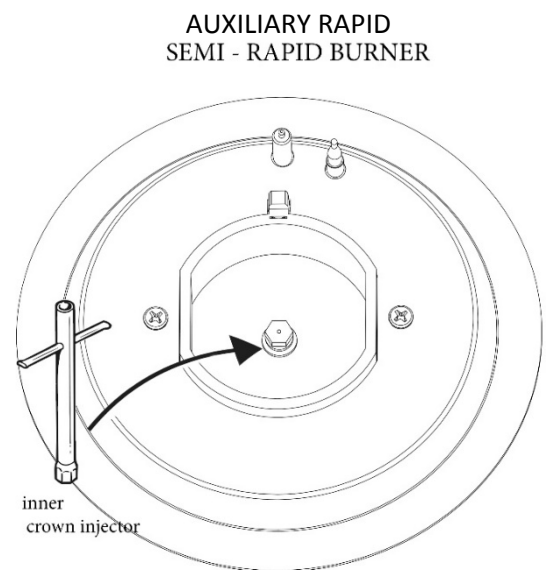
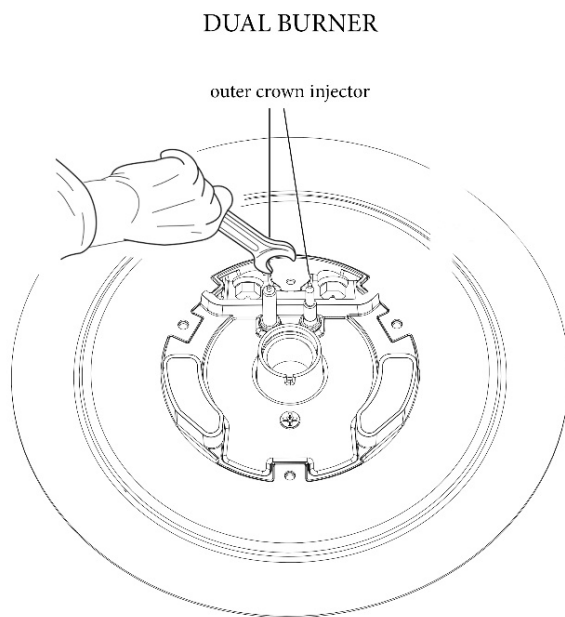

## TEPPANYAKI

The "Teppanyaki" accessory (if available) must be placed over two burners on the cooktop as shown in the photo.



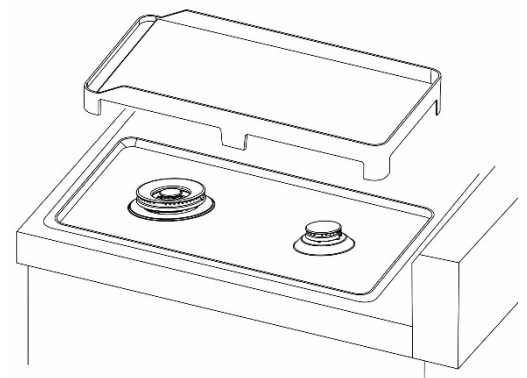





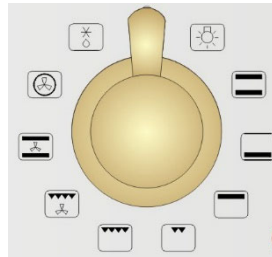

**WARNING: it must not be placed on the cooktop with only one burner.**



# OVEN FUNCTIONS

## FUNCTION SELECTOR KNOB







Icon	Function Name	Description	Notes
	Oven Light	The oven lamp light up.	The lamp is always on in all the cooking functions.
	Conventional Oven	The heat distributes evenly from the top and the bottom. Ideal for baking pastries, cakes & biscuits and roasts.	Recommended for cooking individual items.
	Cooking From Below	The heat distributes from the bottom to give cooked food a finishing touch.	
	Cooking From Above	The heat comes from the top (sky) heating element.	Ideal for cooking the top of dishes without grilling.
	Grilling	The heat is radiated in the oven.	Ideal for cooking on the grill, toasting, browning, gratinating.
	Grilling With Maxi Grill	The heat expands with higher power and greater irradiation surface.	Ideal for cooking on the grill, toasting, browning, gratinating.
	Grilling With Fan-Assisted Oven	The heat is radiated in the oven and evenly distributed by the fan.	Ideal for grilling, toasting, browning, gratin dishes, etc. without the inside of the food drying out.
	Even Cooking	The heat emitted by the top and bottom heating elements is distributed by the fan for quick, even cooking, inside and out.	Recommended for cooking individual items.
	Fan-Assisted Cooking	The heat is distributed by forced ventilation. This cooking system enables you to cook three different dishes at the same time.	Ideal for food that has to be well-cooked in the middle and not well-done on the outside.  <b>Super fast defrosting:</b> Set the switch to “fan-assisted cooking” and the thermostat to 120°F in order to defrost food in no time at all.
	Defrosting	Set the oven thermostat to “0” position. Food can be defrosted by using the fan without any heat.	

## ELECTRONIC PROGRAMMER







### LIST OF FUNCTIONS

-  Timer key
-  End of cooking key
-  Cooking duration key
-  Value decrease key
-  Value increase key

### Setting the time

On the first use, or after a power failure, **0000** will be flashing on the oven's display.



Press the  and  keys together, and at the same time press the value adjustment keys  or : this will increase or decrease the setting by one minute for each press.



Press either of the value modification keys to display the current time.

Before each programmer setting, activate the required function and temperature.

### Timed cooking



**Timed cooking is the function which allows a cooking operation to be started and then ended after a specific length of time set by the user.**



Press the  key and the display will light up showing the figures **0000**; keep it pressed, and at the same time use the keys  or  to set the cooking duration.

When  is released, the count of the programmed cooking duration will start and the display will show the current time together with  and **A** (to indicate that a programmed cooking operation has been set).

### Programmed cooking



This function switches the oven on and off in fully automatic mode.

Press the  key and the display will light up showing the figures **0000**; keep it pressed, and at the same time use the value modification keys  or  to set the cooking duration.

Press the  key and the display will show the sum of the current time plus the cooking duration: keep it pressed, and at the same time use the value modification keys  or  to adjust the end of cooking time.



When the  key is released, the programmed count will start and the display will show the current time together with the symbols **A** and .







**After making the setting, press the  key to view the remaining cooking time; press the  key to view the cooking end time. The logic prevents the setting of incompatible values (e.g. the programmer will not accept a cooking end time with a duration which is too long for its value).**

### **End of cooking**

At the end of the cooking time the oven will switch off automatically and simultaneously a buzzer will start to sound intermittently. After the buzzer has been deactivated, the display will return to show the current time together with the  symbol to indicate that the oven has returned to manual use mode.

### **Timer**

The programmer can also be used as an ordinary timer.

Press the  key and the display will show the figures ; keep  pressed and simultaneously press the value modification keys  or . When the key is released the count will start and the display will show the current time and the symbol .



**After the setting, to display the time left press the  key.**

**In timer mode, the oven operation will not be cut out at the end of the set time.**

### **Adjusting the buzzer volume**



The buzzer volume can be varied (3 settings) while it is in operation by pressing .

### **Stopping the buzzer**

The buzzer stops automatically after about seven minutes. It can be deactivated manually by pressing keys  and  together.

To switch off the appliance, return all the knobs to the 0 setting.

### **Deleting the set data**

Having programmed a timed or programmed cooking operation, this programming can be cancelled by holding down the key for the function which has just been programmed and simultaneously pressing  or  until  appears on the display.

The programmer will interpret the cancellation of the program as terminating the cooking operation.

## **Modifying the set data**

The set cooking data can be modified at any time by holding down the function key and at the same time pressing the keys **−** or **+** to change the value.

---

## **MODEL AND SERIAL NUMBER LOCATION**

The serial plate is located on the oven front frame behind the oven door or on the drawer side frame.

When ordering parts for or making inquiries about your range, always be sure to include the model and serial numbers and a lot number or letter from the serial plate on your range. Your serial plate also tells you the rating of the burners, the type of fuel and the pressure the range was adjusted for when it left the factory.

### **Marking shall comply with CAN/CSA – C22.2 No. 0.**

### **Adhesive nameplates shall comply with the applicable requirements of CSA C22.2 No. 0.15.**

These adhesive nameplates must have:

- Manufacturer's name and trademark
- Model number
- Rated input voltage
- Frequency in hertz
- Rated input in amperes or watts
- Number of phases
- Date code, serial number, month and year of manufacture.

## **BEFORE YOU CALL FOR SERVICE**

Read the Avoid Service Checklist and operating instructions in your Use and Care Guide. It may save you time and expense. The list includes common occurrences that are not the result of defective workmanship or materials in this appliance.

Refer to the warranty and service information in your Use and Care Guide for phone number and address.

Please call or write if you have inquiries about your range product and/or need to order parts.

## SEAL THE OPENINGS

Seal any openings in the wall behind the range and in the floor under the range after gas supply line is installed.

## CONNECT THE RANGE TO THE GAS SUPPLY

---

Important: remove all packing material and literature from range before connecting gas and electrical supply.

To prevent leaks, put pipe joint sealant on all external pipe threads.

The supply line should be equipped with an approved shutoff valve. This valve should be located in the same room as the range and should be in a location that allows ease of opening and closing.

Do not block access to the shutoff valve. The valve is for turning on or shutting off gas to the appliance.

Open the gas shutoff valve in the gas supply line. Wait 5 minutes for gas to move through the gas line.

The gas supply between the shutoff valve and the regulator may be connected by rigid piping or by A.G.A./C.G.A.-approved flexible metallic union- connected piping where local codes permit use.



### **CAUTION:**

Do not allow regulator to rotate on pipe when tightening fittings.

## CONNECTION TO PRESSURE REGULATOR

The regulator is already installed on the appliance.



### **CAUTION:**

Do not make the connection too tight. The regulator is die cast. Overtightening may crack the regulator resulting in a gas leak and possible fire or explosion.

The user must know the location of the main shutoff valve and have easy access to it. When using flexible gas conduit on the range, allow sufficient slack to pull the range outside the cut-out for the cleaning or servicing.

**NOTE:**

Do not allow the flexible conduit to get pinched between the wall and the range. To visually check, remove the range drawer.

If flexible connectors are used, be certain connectors are not kinked.

---

**MOVING THE APPLIANCE FOR SERVICING AND CLEANING**

---

**WARNING:**

**When raising cooker to upright position always ensure two people carry out this manoeuvre to prevent damage to the adjustable feet.**

**Be careful: do not lift the cooker by the door handle when raising to the upright position.**

**When moving cooker to its final position, DO NOT DRAG. Lift feet clear of floor.**

**WARNING:**

**Before cleaning the appliance, remove broiler trays and other utensils and wiping off all excessive spillage before initiating the cleaning cycle.**

**Do not clean door gasket: the door gasket is essential for a good seal. Care should be taken not to rub, damage, or move the gasket.**

**Do not use oven cleaners: no commercial oven cleaner or oven liner protective coating of any kind should be used in or around any part of the oven.**

**Clean only parts listed in manual.**

**Before self-cleaning the oven: remove broiler pan and other utensils.**

Turn off the range line fuse or circuit breakers at the main power source, and turn off the manual gas shut-off valve.

Make sure the range is cold. Remove the service drawer (warming drawer on some models) and open the oven door.

Lift the range at the front and slide it out of the cut-out opening without creating undue strain on the flexible gas conduit. Make sure not to pinch the flexible gas conduit at the back of the

range when replacing the unit into the cut-out opening. Replace the drawer, close the door and switch on the electrical power and gas to the range.

NOTE

---

---

---

---

---

---

---

NOTE

---

---

---

---

---

---

---

---

# **LOFRA®**

**Nuova Lofra S.r.l.**

**Via Montegrotto, 125 - 35038 TORREGLIA (PADOVA) - ITALY**

**Tel.: +39 049 9904811**

**Telefax: +39 049 9904800**

**Website: [www.lofra.it](http://www.lofra.it)**