

# Installation Instructions

---

## Over The Range Microwave Oven

### BEFORE YOU BEGIN (Read these instructions completely and carefully.)

**IMPORTANT**

Save these instructions for local inspector's use.

**IMPORTANT**

Observe all governing codes and ordinances.

- **Note to Installer** - Be sure to leave these instructions with the Consumer.
- **Note to Consumer** - Keep these instructions for future reference.
- **Skill level** - Installation of this appliance requires basic mechanical and electrical skills.
- **Proper installation is the responsibility of the installer.**
- **Product failure due to improper installation is not covered under the Warranty.**

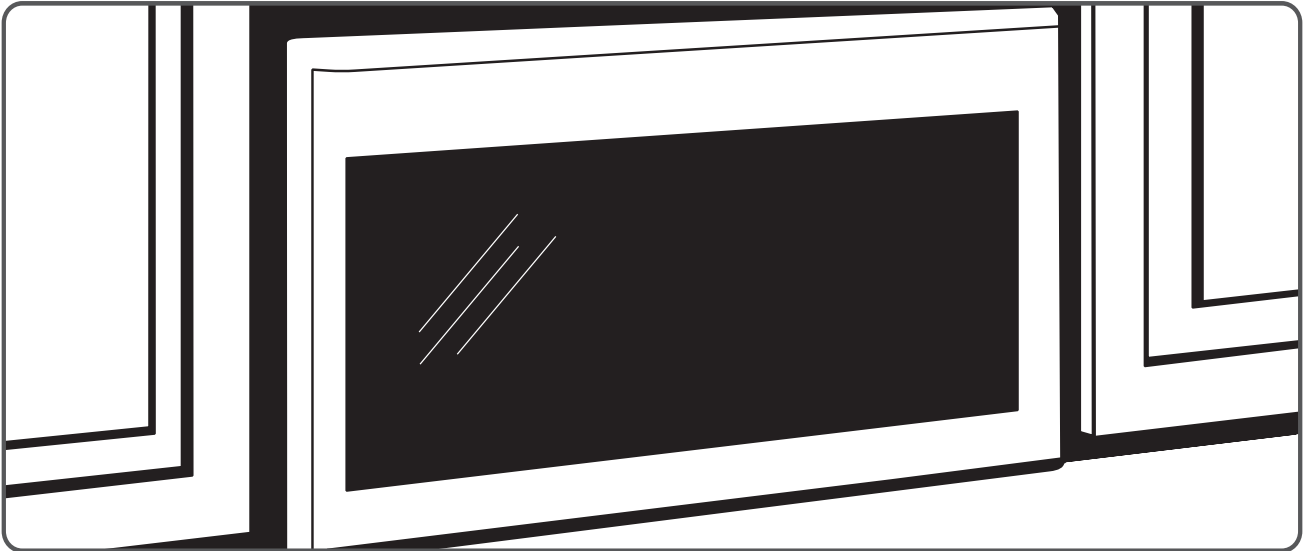

**READ CAREFULLY. KEEP THESE INSTRUCTIONS.**

# Contents

## General information

Important safety instructions .....	3
Electrical requirements .....	3
Hood exhaust .....	4
Damage - Shipment/Installation .....	6
Parts included .....	6
Tools you will need .....	7
Mounting space .....	7

## Step-by-step installation guide

<b>1. Placement of the mounting plate .....</b>	<b>8</b>
A. Removing the microwave oven from the carton/Removing the mounting plate .....	8
B. Finding the wall studs .....	8
C. Determining wall plate location under your cabinet .....	9
D. Aligning the wall plate .....	10
<b>2. Ventilation types (choose a, b or c) .....</b>	<b>11</b>
A. Outside top exhaust (vertical duct) .....	12
A1. Installation procedure for THE exhaust adaptor and proper damper operation check .....	12
A2. Adjust the exhaust adaptor .....	12
B. Recirculating (non-vented ductless) .....	12
B1. Adapting the microwave blower for recirculation .....	12
B2. Installing the charcoal filter .....	13
C. Outside back exhaust (horizontal duct) .....	14
C1. Adapting the microwave blower for outside back exhaust .....	14
<b>3. Installation .....</b>	<b>15</b>
A. Prepare the rear wall for outside back exhaust	15
B. Attach the mounting plate to the wall .....	15
C. Use the top cabinet template to prepare the CABINET ABOVE .....	16
D. Mount the microwave oven .....	16
E. Connect THE ductwork for outside top exhaust	17
<b>4. Before you use your microwave .....</b>	<b>18</b>

## IMPORTANT SAFETY INSTRUCTIONS

This product requires a three-prong grounded outlet. The installer must perform a ground continuity check on the power outlet box before beginning the installation to ensure that the outlet box is properly grounded. If not properly grounded, or if the outlet box does not meet electrical requirements noted (under ELECTRICAL REQUIREMENTS), a qualified electrician should be employed to correct any deficiencies.

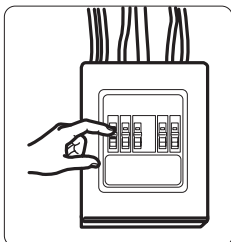

**CAUTION:** For personal safety, remove the house fuse or open the circuit breaker before beginning the installation to avoid severe or fatal shock injury.

**CAUTION:** For personal safety, the mounting surface must be capable of supporting the cabinet load in addition to the added weight of this 69 pound product, plus additional oven loads of up to 50 pounds or a total weight of 109 pounds.

**CAUTION:** For personal safety, do not install this product in cabinetry configured as an island or a peninsula. The microwave oven must be mounted to BOTH a top cabinet AND a wall.

**NOTE:** For easier installation and personal safety, we recommend that two people install this product.

**IMPORTANT – PLEASE READ CAREFULLY. FOR PERSONAL SAFETY, THIS APPLIANCE MUST BE PROPERLY GROUNDED TO AVOID SEVERE OR FATAL SHOCK.**

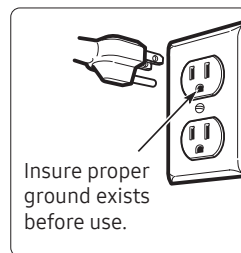

**The power cord of this appliance is equipped with a three-prong (grounding) plug which mates with a standard three-prong (grounding) wall receptacle to minimize the possibility of electric shock hazard from this appliance.**

You should have the wall receptacle and circuit checked by a qualified electrician to make sure the receptacle is properly grounded.

If you have a standard two-prong wall receptacle, it is very important to have it replaced with a properly grounded three-prong wall receptacle, installed by a qualified electrician.

**DO NOT, UNDER ANY CIRCUMSTANCES, CUT, DEFORM OR REMOVE ANY OF THE PRONGS FROM THE POWER CORD. DO NOT USE WITH AN EXTENSION CORD.**

## ELECTRICAL REQUIREMENTS

Product rating is 120 volts AC, 60 Hertz. This product must be connected to a supply circuit of the proper voltage and frequency. Wire size must conform to the requirements of the National Electrical Code or the prevailing local code for this kilowatt rating. The power supply cord and plug should be brought to a separate branch circuit single grounded outlet of at least 15 A and max of 20 A. 20 A is recommended for multifamily buildings. The outlet box should be located in the cabinet above the microwave oven. The outlet box and supply circuit should be installed by a qualified electrician and conform to the National Electrical Code or the prevailing local code.

# General information



## HOOD EXHAUST

**NOTE:** Read these next two pages only if you plan to vent your exhaust to the outside. If you plan to recirculate the air back into the room, proceed to page 11.

### OUTSIDE TOP EXHAUST (EXAMPLE ONLY)

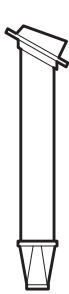
The following chart contains an example of one possible ductwork installation.





DUCT PIECES		EQUIVALENT LENGTH	x	NUMBER USED	=	EQUIVALENT LENGTH	
	Roof Cap	24 ft.	x	(1)	=	24 ft.	
	12 Ft. Straight Duct (6" Round)	12 ft.	x	(1)	=	12 ft.	
	Rectangular-to-Round Transition Adaptor*	5 ft.	x	(1)	=	5 ft.	
Equivalent lengths of duct pieces are based on actual tests and reflect requirements for good venting performance with any vent hood.					<b>Total Length</b>	<b>=</b>	<b>41 ft.</b>

**\* IMPORTANT:** If a rectangular-to-round transition adaptor is used, the bottom corners of the damper will have to be cut to fit, using the tin snips, in order to allow free movement of the damper.

### OUTSIDE BACK EXHAUST (EXAMPLE ONLY)

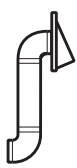
The following chart contains an example of one possible ductwork installation.

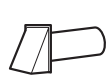

DUCT PIECES		EQUIVALENT LENGTH	x	NUMBER USED	=	EQUIVALENT LENGTH	
	Wall Cap	40 ft.	x	(1)	=	40 ft.	
	3 Ft. Straight Duct (3 1/4" x 10" Rectangular)	3 ft.	x	(1)	=	3 ft.	
	90° Elbow	10 ft.	x	(2)	=	20 ft.	
Equivalent lengths of duct pieces are based on actual tests and reflect requirements for good venting performance with any vent hood.					<b>Total Length</b>	<b>=</b>	<b>63 ft.</b>

**NOTE:** For back exhaust, care should be taken to align the exhaust with the space between studs, or the wall should be prepared at the time it is constructed by leaving enough space between the wall studs to accommodate exhaust.

**NOTE:** If you need to install ducts, note that the total duct length of 3 ¼" x 10" rectangular or 6" diameter round duct should not exceed 140 equivalent feet.

Outside ventilation requires a HOOD EXHAUST DUCT. Read the following carefully.

**NOTE:** It is important that venting be installed using the most direct route and with as few elbows as possible. This ensures clear venting of exhaust and helps prevent blockages. **Also, make sure dampers swing freely and nothing is blocking the ducts.**

### Exhaust connection:







The hood exhaust has been designed to mate with a standard 3 ¼" x 10" rectangular duct.

If a round duct is required, a rectangular-to-round transition adaptor must be used. **Do not use less than a 6" diameter duct.**

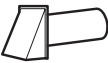
### Maximum duct length:

For satisfactory air movement, the total duct length of 3 ¼" x 10" rectangular or 6" diameter round duct should not exceed 140 equivalent feet.

**Elbows, transitions, wall and roof caps, etc.** present additional resistance to airflow and are equivalent to a section of straight duct which is longer than their actual physical size. When calculating the total duct length, add the equivalent lengths of all transitions and adaptors plus the length of all straight duct sections. The chart below shows you how to calculate total equivalent ductwork length using the equivalent length in feet of some typical ducts.

DUCT PIECES		EQUIVALENT LENGTH	x	NUMBER USED	=	EQUIVALENT LENGTH
	Rectangular-to-Round Transition Adaptor*	5 ft.	x	( )	=	ft.
	Wall Cap	40 ft.	x	( )	=	ft.
	90 ° Elbow	10 ft.	x	( )	=	ft.
	45 ° Elbow	5 ft.	x	( )	=	ft.
	90 ° Elbow	25 ft.	x	( )	=	ft.
	45 ° Elbow	5 ft.	x	( )	=	ft.
	Roof Cap	24 ft.	x	( )	=	ft.
	Straight Duct 6" Round or 3 ¼" x 10" Rectangular	1 ft.	x	( )	=	ft.
<b>Total Ductwork</b>					<b>=</b>	<b>ft.</b>



\* **IMPORTANT:** If a rectangular-to-round transition adaptor is used, the bottom corners of the damper will have to be cut to fit, using tin snips, to allow free movement of the damper.

Equivalent lengths of duct pieces are based on actual tests and reflect the requirements for good venting performance with any vent hood.



# General information

## DAMAGE - SHIPMENT/INSTALLATION

- **If the unit is damaged in shipment**, return the unit to the store in which it was bought for repair or replacement.
- **If the unit is damaged by the customer**, repair or replacement is the responsibility of the customer.
- **If the unit is damaged by the installer** (if other than the customer), repair or replacement must be made by arrangement between the customer and installer.

## PARTS INCLUDED





### HARDWARE PACKET

	PART	QUANTITY
	Wood Screws (1/4" x 2")	1
	Toggle Bolts (and wing nuts) (3/16" x 3")	2
	Self-aligning Machine Screws (1/4" - 28 x 3 1/4")	2



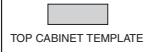



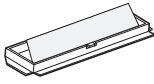





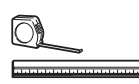

You will find the installation hardware contained in a packet with the unit. Check to make sure you have all these parts.

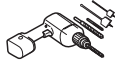
**NOTE:** Some extra parts are included.

### ADDITIONAL PARTS

	PART	QUANTITY
	Top Cabinet Template	1
	Rear Wall Template	1
	Installation Instructions	1
	One Touch Easy Grease Filter	1 (Installed)
	Exhaust adaptor	1

## TOOLS YOU WILL NEED

			
# 1 and #2 Phillips screwdriver	Pencil	Ruler or tape measure and straight edge	Carpenter square (optional)
			
Tin snips (for cutting damper, if required)	Scissors (to cut template, if necessary)	Electric drill with $\frac{3}{16}$ " , $\frac{1}{2}$ " and $\frac{5}{8}$ " drill bits	Filler blocks or scrap wood pieces, if needed for top cabinet spacing (used on recessed bottom cabinet installations only)
			
Gloves	Saw (saber, hole or keyhole)	Stud finder or Hammer (optional)	Safety goggles
			
Level	Duct and masking tape		

## MOUNTING SPACE

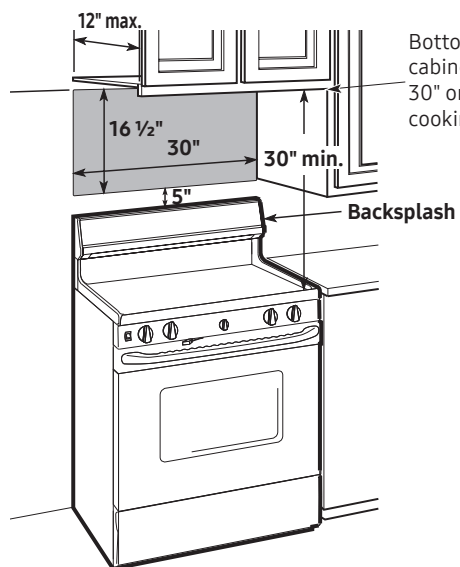

Bottom edge of the cabinet needs to be 30" or more from the cooking surface.

Backsplash

**NOTES:**

- The space between the cabinets must be 30" wide and free of obstructions.
- This microwave oven is for installation over ranges up to 36" wide.
- If you are going to vent your microwave oven to the outside, see the Hood Exhaust Section for exhaust duct preparation.
- **If installing the microwave oven beneath smooth flat cabinets, be careful to follow the instructions on the top cabinet template for power cord clearance.**
- **Maximum cabinet depth above and beside the unit is 12".**
- **The dimensions provided are the minimum required for mounting the microwave oven. Local codes and the practical use of the range will likely require you to provide more than the 13.5" shown between the range and the bottom of the microwave.**

# Step-by-step installation guide

## 1. PLACEMENT OF THE MOUNTING PLATE

### A. REMOVING THE MICROWAVE OVEN FROM THE CARTON/REMOVING THE MOUNTING PLATE

1. Remove the installation instructions, Exhaust adaptor, filters, glass tray, and the small hardware bag. Do not remove the Styrofoam protecting the front of the oven.
2. Fold back all 4 carton flaps fully against carton sides. Then carefully roll the oven and carton over onto the top side. The oven should be resting in the Styrofoam.

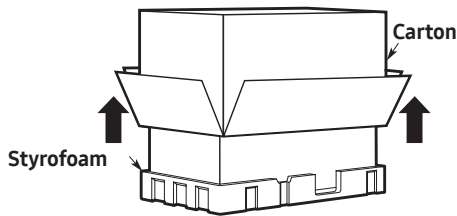

3. Pull the carton up and off the oven.
4. Remove and properly discard plastic bags.

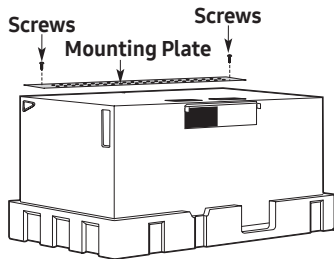

5. Remove the 2 screws from the mounting plate. This plate will be used as the rear wall template and for mounting.

**NOTE:** Retain the two screws. You will need to re-insert the screws in their original locations after you have removed the mounting plate.

### B. FINDING THE WALL STUDS

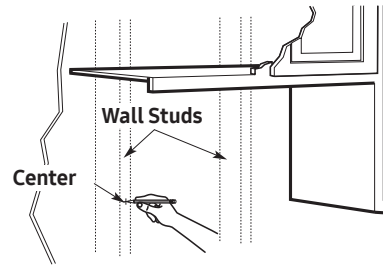

1. Find the studs using one of the following methods:
  - A. With a stud finder – a magnetic device which locates nails.

**OR**

  - B. Use a hammer to tap lightly across the mounting surface until you hear a solid sound. This will indicate a stud location.
2. After locating the stud(s), locate the stud's center by probing the wall with a small nail to find the edges of the stud. Then, place a mark halfway between the edges. The center of any adjacent studs should be 16" or 24" from this mark.
3. Draw a line down the center of the studs.

**THE MICROWAVE MUST BE CONNECTED TO AT LEAST ONE WALL STUD.**



## C. DETERMINING WALL PLATE LOCATION UNDER YOUR CABINET

### Plate position – beneath a flat bottom cabinet.

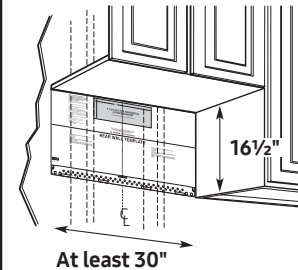

Draw a vertical line on the wall at the center of the 30" wide space. Tape the Rear Wall Template onto the wall so that the top of the template touches the bottom of the cabinet and the centerline on the template lines up with the line you drew on the wall.

### Plate position – beneath a framed recessed cabinet bottom.

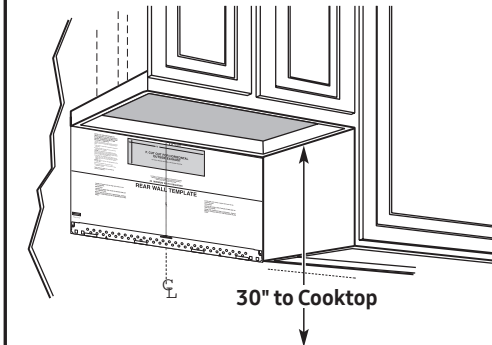

Draw a vertical line on the wall at the center of the 30" wide space. Tape the Rear Wall Template onto the wall so that the top of the template touches the bottom of the cabinet frame and the centerline on the template lines up with the line you drew on the wall.

### Plate position – beneath a recessed bottom cabinet with a front overhang.

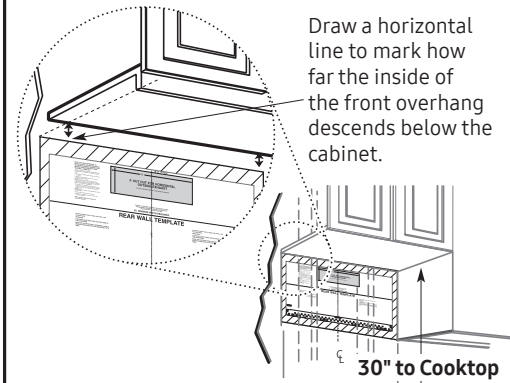

Draw a horizontal line to mark how far the inside of the front overhang descends below the cabinet.

Draw a vertical line on the wall at the center of the 30" wide space. Draw a second, horizontal line on the wall below the cabinet to mark how far the inside of the front overhang descends below the cabinet. Tape the Rear Wall Template onto the wall so that the top of the template touches the bottom of the horizontal line and the centerline on the template lines up with the vertical line.

Your cabinets may have decorative trim that interferes with the microwave installation. Remove the decorative trim to install the microwave properly and to make it level.

### THE MICROWAVE MUST BE LEVEL.

Use a level to make sure the cabinet bottom is level.

# Step-by-step installation guide

## D. ALIGNING THE WALL PLATE

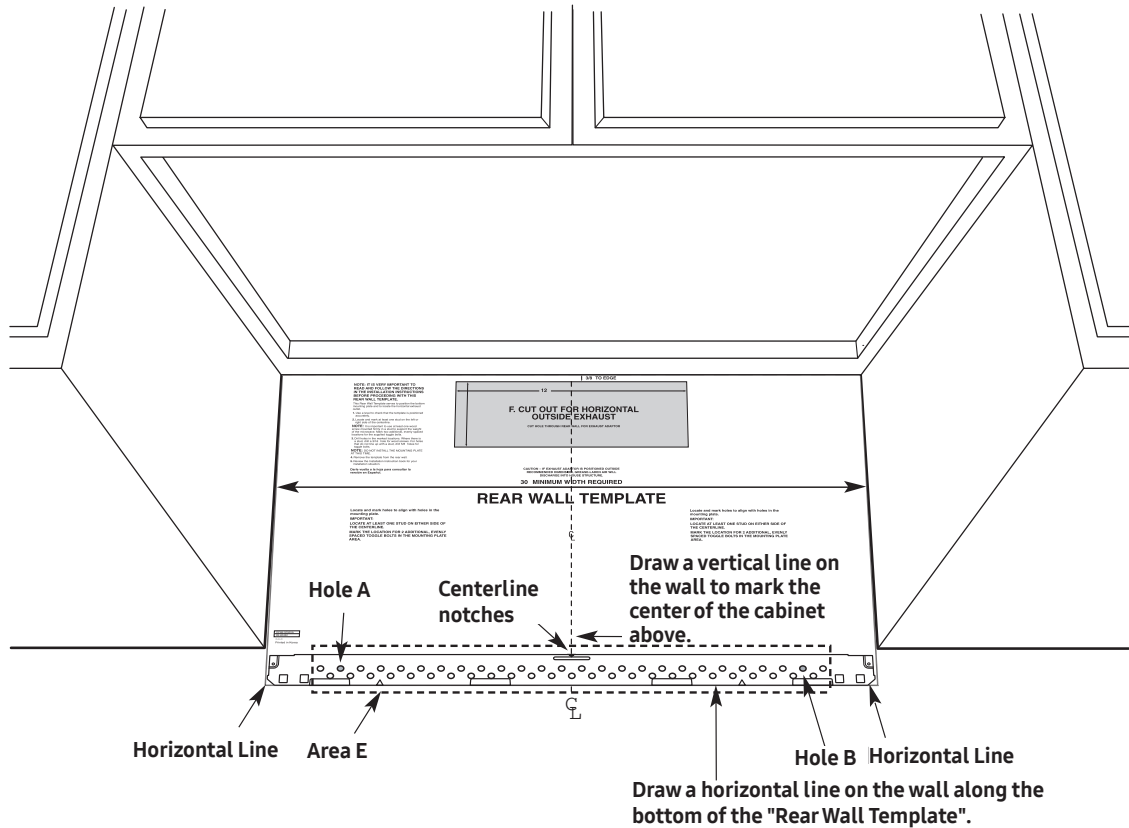

**CAUTION:** Wear gloves to avoid cutting fingers on sharp edges.

1. Draw a horizontal line on the wall at the bottom of the "Rear Wall Template".
2. Drill  $\frac{5}{8}$ " holes for toggle bolts in 3 locations (Hole A, Hole B, Hole C) as shown in the illustration above. If the location of a hole lines up with a stud, drill a  $\frac{3}{16}$ " hole for a wood screw. You cannot use a toggle bolt to attach the wall plate to a stud.
3. Holes A, B and C are inside area E. If none of these holes line up with a stud, find a stud in area E that lines up with a hole circle in Area E, and then drill a  $\frac{3}{16}$ " hole into it for a wood screw. You must have at least one wood screw mounted firmly into a stud to support the weight of the microwave. **Set the mounting plate aside.**

**NOTE:** DO NOT MOUNT THE PLATE AT THIS TIME.

## 2. VENTILATION TYPES (CHOOSE A, B OR C)

This microwave oven is compatible with the following three types of ventilation:

- A. Outside Top Exhaust (Vertical Duct)**
- B. Recirculating (Non-Vented Ductless)**
- C. Outside Back Exhaust (Horizontal Duct)**

**NOTE:** This microwave is shipped assembled for Outside Top Exhaust (except for non-vented models). An exhaust adaptor is shipped assembled and attached to the filler-upper. Select the type of ventilation required for your installation and proceed to that section.

### A. OUTSIDE TOP EXHAUST (VERTICAL DUCT)

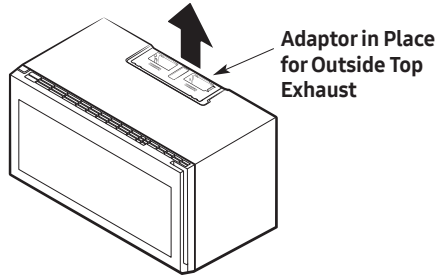

See page 12

### B. RECIRCULATING (NON-VENTED DUCTLESS)

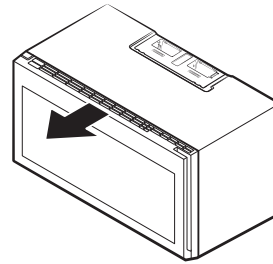

See page 12, Part B

**IMPORTANT:** You must install the included Charcoal Filter if you select nonvented exhaust. The charcoal filter is provided with the unit.

### C. OUTSIDE BACK EXHAUST (HORIZONTAL DUCT)

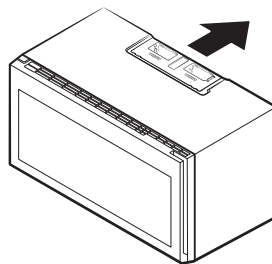

See page 14

# Step-by-step installation guide

## A. OUTSIDE TOP EXHAUST (VERTICAL DUCT)

### A1. INSTALLATION PROCEDURE FOR THE EXHAUST ADAPTOR AND PROPER DAMPER OPERATION CHECK

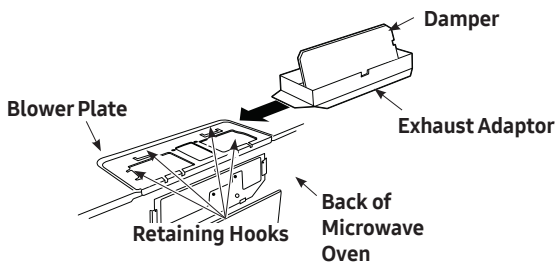

1. Slide the exhaust adaptor into place as shown in the diagram above.
2. Make sure the tape securing the damper is removed and damper pivots easily before you mount the microwave.

**CAUTION:** You will need to make adjustments to assure proper alignment with your house exhaust duct after the microwave is installed.

### A2. ADJUST THE EXHAUST ADAPTOR

After you have installed the microwave, you will need to open the top cabinet and adjust the exhaust adaptor so that you can connect it to the house duct.

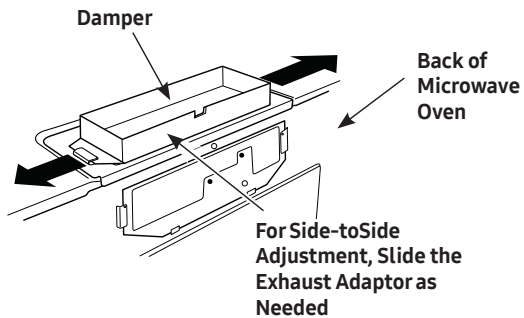

**NOTE:** You must attach the house duct to the exhaust adaptor after installation is complete.

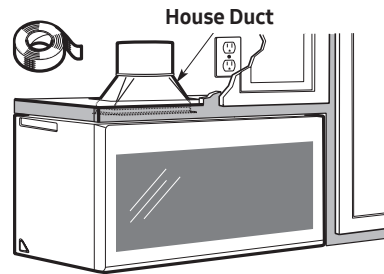

## B. RECIRCULATING (NON-VENTED DUCTLESS)

### B1. ADAPTING THE MICROWAVE BLOWER FOR RECIRCULATION

1. Remove and save screw that holds blower plate to microwave.
2. Lift up the blower plate.

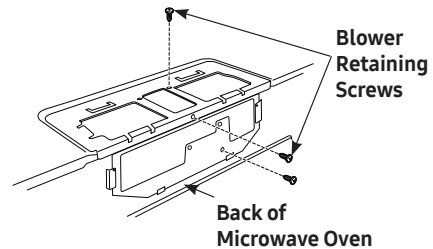

**NOTE:** The exhaust adaptor with the damper is not needed for recirculating models. You may want to save them for possible future use.

3. Remove the screw that holds the blower motor and carefully pull out the blower unit. The wires will extend far enough to allow you to adjust the blower unit.

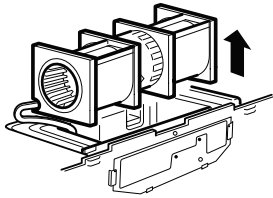

**CAUTION:** To avoid breaking or cracking the blower blade, do not touch the blade. Hold the outer case of the blower when you pull it out or put it back in place.

4. Roll the blower unit 90° so that the fan blade openings are facing toward the front of the microwave.

Before Roll

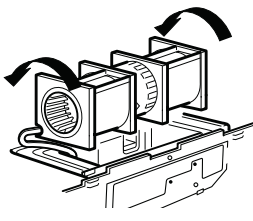

After Roll

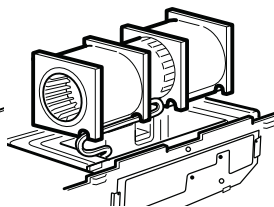

5. Place the blower unit back into the opening.

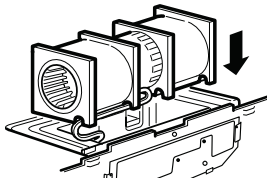

**CAUTION:** Do not pull or stretch the blower unit wiring. Make sure the wires are not pinched.

6. Remove the metal vent fan cover on the back of the microwave by sliding it up.

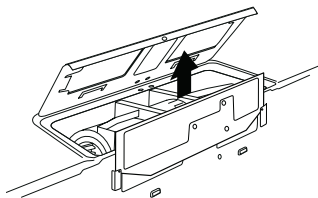

7. Close the blower door. Slide blower shield onto the top of the blower door opening.

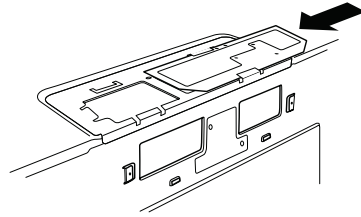

8. Secure the blower to the microwave using the blower retaining screws from Step 1.

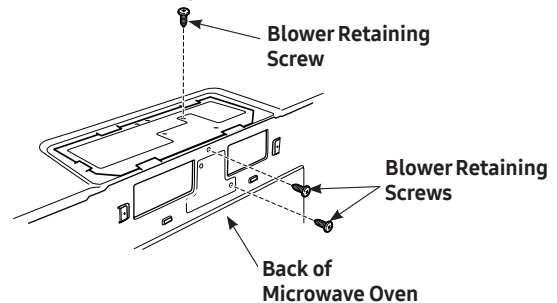

## B2. INSTALLING THE CHARCOAL FILTER

1. Open the door before turning on the power at the main power supply.
2. Remove the vent grille mounting screws.
3. Slide the vent grille to the left, then pull it straight out.
4. Install the charcoal filter. Slide a new charcoal filter into place. The filter should rest at the angle shown.

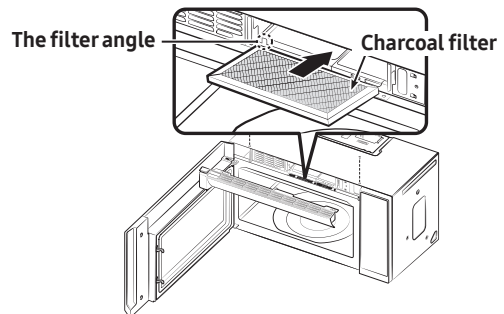

5. Replace the vent grille and 2 screws.
6. Close the door.

# Step-by-step installation guide

## C. OUTSIDE BACK EXHAUST (HORIZONTAL DUCT)

### C1. ADAPTING THE MICROWAVE BLOWER FOR OUTSIDE BACK EXHAUST

1. Remove and save screw that holds blower Plate to microwave.

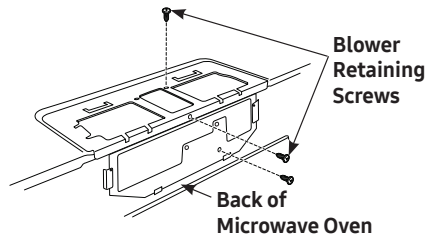

2. Open the blower door by lifting it up at the back of the microwave. Remove and save the blower shield on the back of the microwave by sliding it up. Remove and save the metal vent fan cover on the back of the microwave by sliding it up.

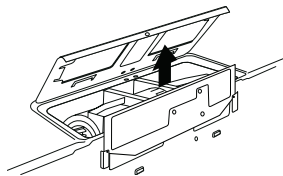

3. Carefully pull out the blower unit. The wires will extend far enough to allow you to adjust the blower unit.

**BEFORE: Fan Blade Openings Facing Forward**

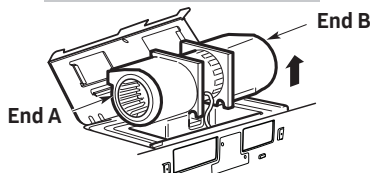

**CAUTION:** To avoid breaking or cracking the blower blade, do not touch the blade. Hold the outer case of the blower when you pull it out or put it back in place.

4. Remove Parts "A" with tin snips or pliers.

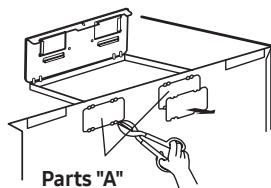

5. Rotate the blower unit counterclockwise 180°.

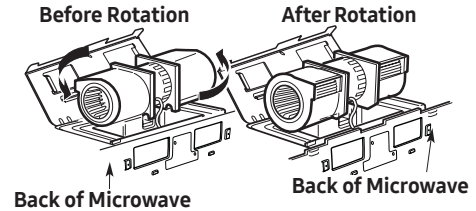

6. Place the blower unit back into the opening.

**AFTER: Fan Blade Openings Facing Back**

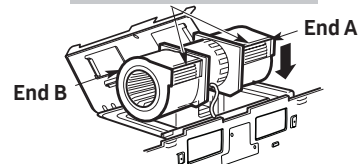

**CAUTION:** Do not pull or stretch the blower unit wiring. Make sure the wires are not pinched.

**NOTE:** The blower unit exhaust openings should match the exhaust openings on the rear of the microwave oven.

7. Close the blower door. Slide blower shield onto the top of the blower door opening. Secure the blower to the microwave oven using the blower retaining screws from Step 1 except the upper blower motor retaining screw.

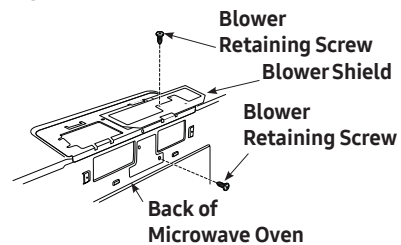

8. Slide the exhaust adaptor onto the back of the microwave oven, securing it into the lower locking tabs. Take care to ensure that the damper hinge is installed so that it is at the top and that the damper swings freely. Reinstall the upper blower motor screw through the adaptor and the blower door and into the back of the microwave oven.

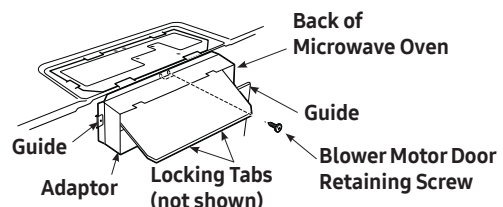

## 3. INSTALLATION

### INSTALLATION OVERVIEW

- A. Prepare the Rear Wall (for outside back exhaust/horizontal duct only)
- B. Attach the Mounting Plate to the Wall
- C. Prepare the Cabinet above
- D. Mount the Microwave Oven
- E. Connect the Ductwork (for outside top exhaust/vertical duct only)

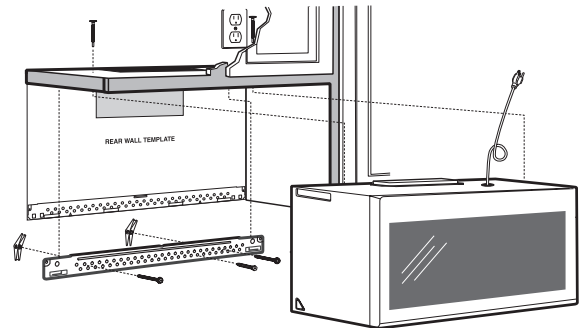

### A. PREPARE THE REAR WALL FOR OUTSIDE BACK EXHAUST

You need to cut an opening in the rear wall for outside exhaust.

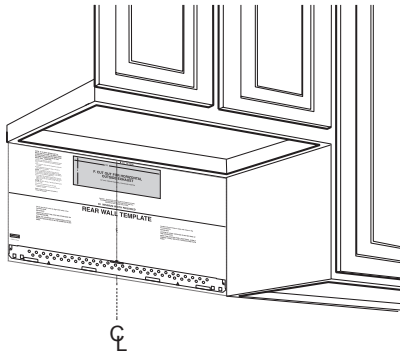

- Read the instructions for outside back exhaust on the REAR WALL TEMPLATE.
- Tape the REAR WALL TEMPLATE to the rear wall.
- Cut the opening, following the instructions on the REAR WALL TEMPLATE.

**CAUTION:** Do not cut an opening in the rear wall if you are installing the microwave with vertical duct or non-vented ductless ventilation.

### B. ATTACH THE MOUNTING PLATE TO THE WALL

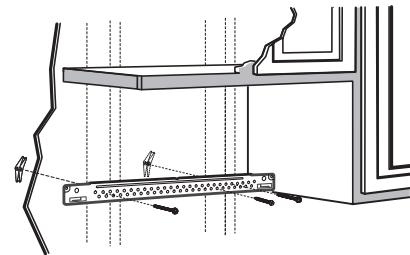

Attach the plate to the wall using toggle bolts. At least one wood screw must be used to attach the plate to a wall stud.

1. Remove the toggle wings from the bolts.
2. Insert the bolts into the mounting plate through the holes designated to go into drywall, and then reattach the toggle wings so that  $\frac{3}{4}$ " of the bolt protrudes beyond the wing.

# Step-by-step installation guide

## To use the toggle bolts:

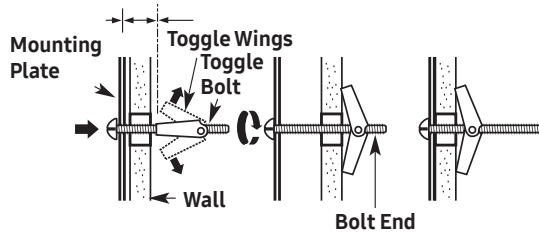

3. Place the mounting plate against the wall, pinch the wings of each toggle together, and then insert the toggle wings of each toggle into and through the holes in the wall.

**NOTE:** Before tightening the toggle bolts and wood screw, make sure the bottom of the Mounting plate runs along the bottom Horizontal line of the "Rear wall Template" and the Mounting plate is properly centered under the cabinet.

**CAUTION:** Be careful to avoid pinching your fingers between the back of the mounting plate and the wall.

4. Tighten all bolts. Pull the plate away from the wall to help tighten the bolts. Tighten the screw.

## C. USE THE TOP CABINET TEMPLATE TO PREPARE THE CABINET ABOVE

You need to drill holes for the top support screws and a hole large enough for the power cord to fit through.

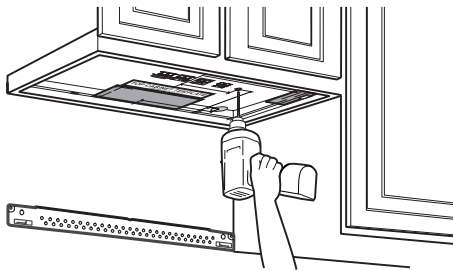

- Read the instructions on the TOP CABINET TEMPLATE.
- Tape it underneath the top cabinet.
- Drill the holes, following the instructions on the TOP CABINET TEMPLATE.

**CAUTION:** Wear safety goggles when drilling holes in the cabinet bottom.

## D. MOUNT THE MICROWAVE OVEN

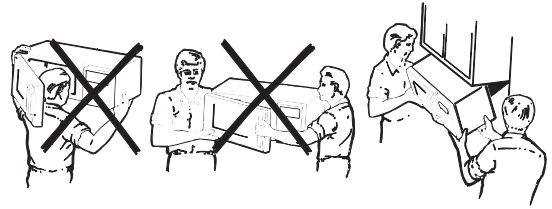

FOR EASIER INSTALLATION AND PERSONAL SAFETY, WE RECOMMEND THAT TWO PEOPLE INSTALL THIS MICROWAVE OVEN.

**IMPORTANT:** Do not grip the handle or use the handle during installation to support the microwave.

**NOTE:** If your cabinet is metal, use the nylon grommet in the power cord hole to prevent the cord from being cut.

**NOTE:** Filler blocks are required when mounting this unit under any cabinet with a recessed bottom or front overhang. (See page 9.)

**IMPORTANT:** The case damage that will occur from over tightening screws if you do not use filler blocks is not covered under warranty.

**IMPORTANT:** For models with the grease filter installed, don't push up on the filter when you mount the oven.

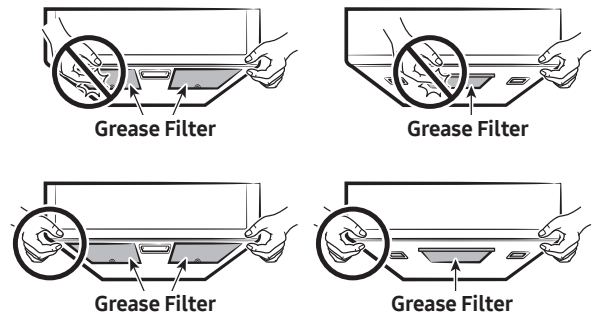

**NOTE:** When mounting the microwave oven, thread the power cord through hole in the bottom of the top cabinet. Keep it tight throughout Steps 1–3. Do not pinch the cord or lift the oven by pulling cord.



# Step-by-step installation guide

1. Lift the microwave, tilt it forward, and hook the slots at the back bottom edge onto the four lower tabs of the mounting plate.

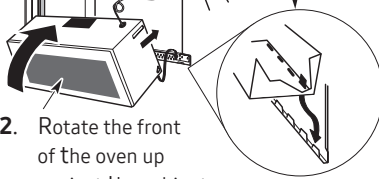

2. Rotate the front of the oven up against the cabinet bottom.

3. Insert a self-aligning screw through the top center cabinet hole. Temporarily secure the oven by turning the screw at least **two full turns** after the threads have engaged. (It will be completely tightened later.) **Be sure to keep the power cord tight. Be careful not to pinch the cord, especially when mounting flush to the bottom of the cabinet.**

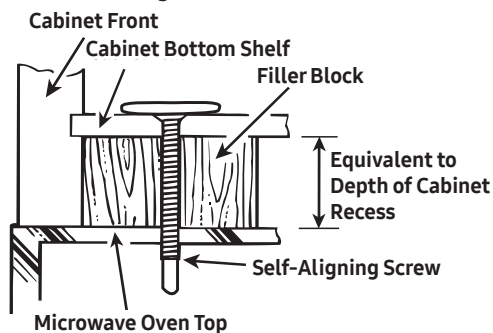

4. Attach the microwave oven to the top cabinet.
5. Insert the 2 self-aligning screws through the cabinet bottom and, if used, through the filler blocks into the outer top of the unit. (See the illustration above). Continue to support the unit until both screws are inserted and engaged at least two full turns, then fully tighten both screws until the unit is secure.

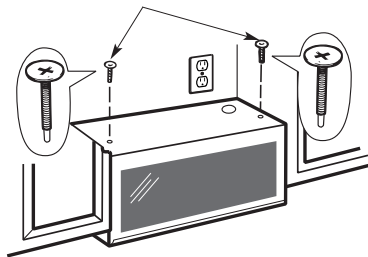

6. Install the grease filters. See the Owner's Manual packed with the microwave for instructions.

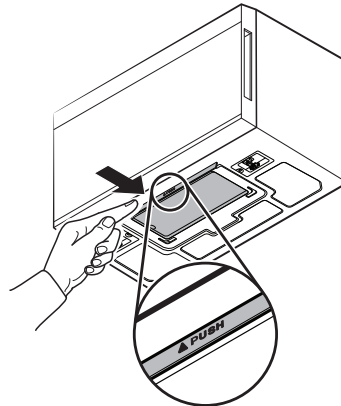
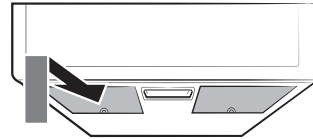

**NOTE:** For models with installed grease filters, you do not need to install a filter

## E. CONNECT THE DUCTWORK FOR OUTSIDE TOP EXHAUST

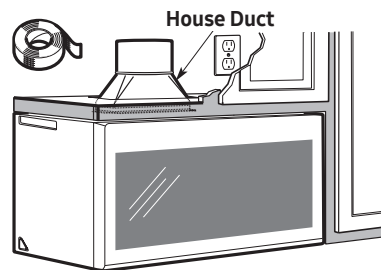

1. Extend the house duct down to connect to the exhaust adaptor.
2. Seal the exhaust duct joints using duct tape.

# Before You Use Your Microwave

## 4. BEFORE YOU USE YOUR MICROWAVE

1. Make sure the microwave oven has been installed according to instructions.



- 
2. Remove all packing material from the microwave oven.

- 
3. Install the turntable and ring in the cavity.

- 
4. Replace the house fuse or turn the breaker back on.

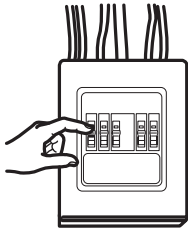

- 
5. Plug the power cord into a dedicated 15 amp electrical outlet.

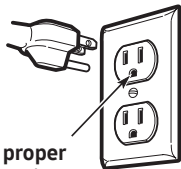

Insure proper ground exists before use.

6. Read the Owner's Manual.



- 
7. Keep installation instructions for the local inspector's use.



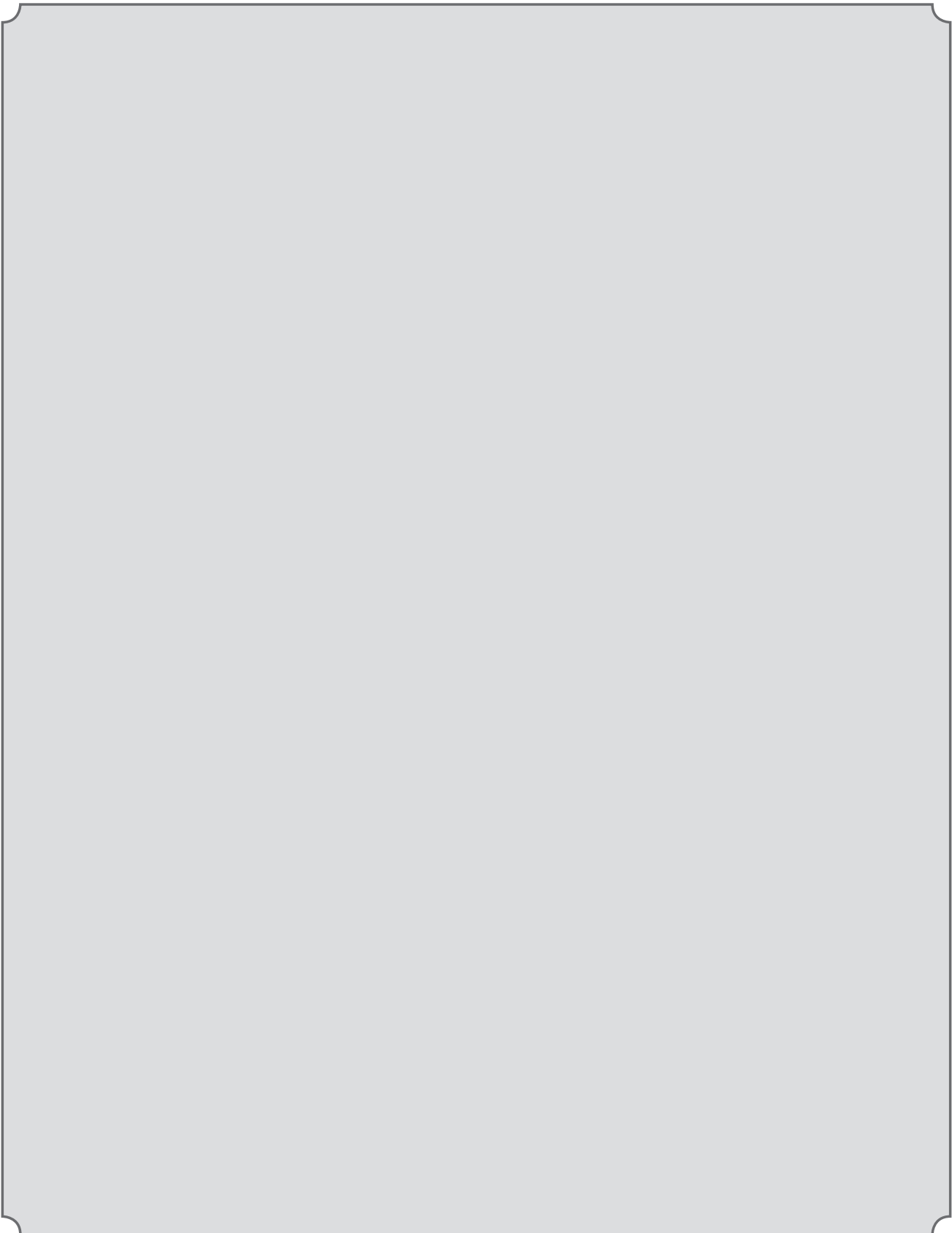

**SAMSUNG**



DE68-04108A-08