

# INDUCTION COOKTOPS

UHCPI366 - UHCPI486

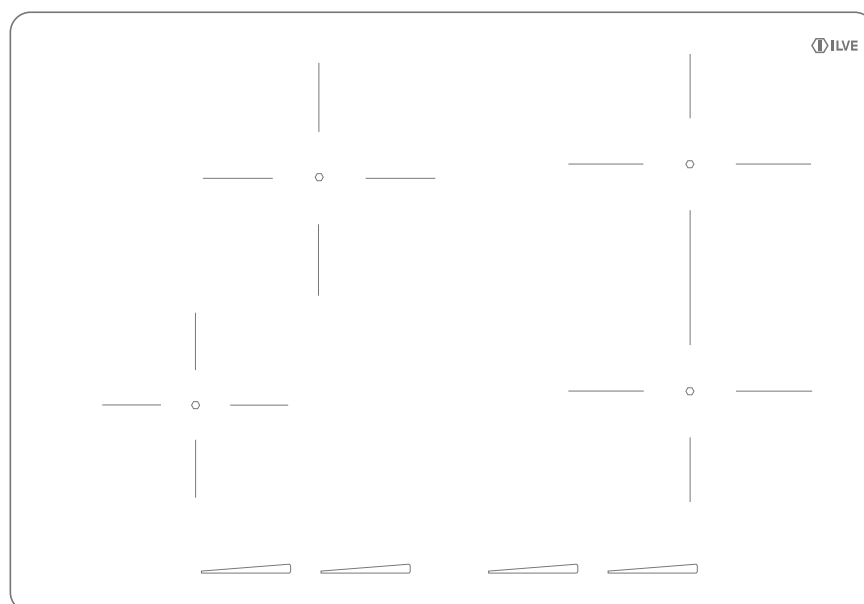

EN | User's manual



# IMPORTANT INSTRUCTION

## - PLEASE READ AND FOLLOW



- Keep appliance area clear and free from combustible materials, gasoline and other flammable vapors and liquids.
- Before beginning, please read these instructions completely and carefully.
- Do not remove permanently affixed labels, warnings, or plates from the product. This may void the warranty.
- Please observe all local and national codes and ordinances.
- Please ensure that this product is properly grounded.
- The installer should leave these instructions with the consumer who should retain for local inspector's use and for future reference.
- Electrical installation must be in accordance with the National Electrical Code, ANSI/NFPA70 latest edition and/or local codes.
- Electrical installation must be in accordance with the current CSA C22.1 Canadian Electrical Codes Part 1 and/or local codes.
- The manufacturer will not be responsible for any damage to property or to persons caused by incorrect installation or improper use of the appliance.
- The manufacturer reserves the right to make changes to its products when considered necessary and useful, without affecting the essential safety and operating characteristics.
- This appliance has been designed for non-professional, domestic use only.
- This appliance must be used only for the purposes for which it was intended. Any other use is incorrect and therefore dangerous.
- Possible hazards may result from using this appliance for storage space.
- Appliances are not intended for manufactured (mobile) home installation.
- Do not touch surface units or areas near units - surface units may be hot even though they are dark in color. Areas near surface units may become hot enough to cause burns. During and after use, do not touch, or let clothing or other inflammable materials contact surface units or areas near units until they have had sufficient time to cool.
- **WARNING: If the information in this manual is not followed exactly, a fire or explosion may result causing property damage, personal injury or death.**

Keep appliance area clear and free from combustible materials, gasoline and other flammable vapors and liquids.

### All Appliances:

- CAUTION: Do Not Leave Children Alone - Children should not be left alone or unattended in area where appliance is in use.
- They should never be allowed to sit or stand on any part of the appliance. Do not store items of interest to children above or at the back of this appliance, as they could climb on the appliance to reach items and be injured.
- Wear Proper Apparel - Loose-fitting or hanging garments should never be worn while using the appliance.
- User Servicing - Do not repair or replace any part of the appliance unless specifically recommended in the manual.
- All other servicing should be referred to a qualified technician.
- Storage in or on Appliance - Flammable materials should not be stored near surface units.
- Do Not Use Water on Grease Fires - Smother fire or flame or use dry chemical or foam type extinguisher.
- Never leave this appliance unattended when in use. Boilovers and greasy spills may smoke or ignite
- Do not heat unopened food containers, such as baby food jars and cans. Pressure build-up may cause the container to burst and cause injury.
- Wear proper apparel. Loose-fitting or hanging garments should never be worn while using this appliance.
- Use extreme caution when moving a grease kettle or disposing of hot grease.
- Clean only those parts listed in this guide.
- Do not repair or replace any part of this appliance unless specifically recommended in literature accompanying this appliance.
- Proper Installation - Be sure your appliance is properly installed and grounded by a qualified technician.
- Never Use Your Appliance for Warming or Heating the Room.

# INDUCTION APPLIANCE

- Use Proper Pan Size - This appliance is equipped with one or more surface units of different size. Select utensil shaving flat bottoms large enough to cover the surface unit heating element. Proper ratio of utensil to cooking zone will also improve efficiency.
- Protective Liners - Do not use aluminum foil to line oven bottom, installation of these liners may result in a risk of electric shock, or fire.
- Avoid spilling water or other liquids onto the Induction Cooker, and never immerse the unit in water.
- Do not touch the Ceramic Plate immediately after cooking - it may be hot from residual heat from the utensil.
- Do not place or store very heavy objects on the ceramic plate.
- The heating area is warmed up from the heat of the pan. To avoid injuries (burning) do not touch the heating area. Do not insert any piece of paper, cardboard, cloth, etc. Between the pan and the heating area, as this might initiate a fire.
- As metallic objects are heated up very quickly when placed on the operating heating area, do not place any other objects (closed cans, aluminium foil, cutlery, jewelry, watches etc.) on the induction cooker.
- Aluminium foil and plastic vessels are not to be placed on the hot surface.
- The surface must not be used for storage.
- Do not place credit cards, phone cards, cassette tapes, or other objects that are sensitive to magnetism on the ceran plate.
- Do not use pans with an uneven bottom. This might cause internal damage.
- If the supply cord is damaged, it must be replaced by the manufacturer, its service agent or a similarly qualified person in order to avoid a hazard.
- Do Not Cook on broken cooktop. If cooktop should break, cleaning solutions and spillovers may penetrate the broken cooktop and create a risk of electric shock. Contact a qualified technician immediately.
- Clean cooktop with caution if a wet sponge or cloth is used to wipe spills on a hot cooking area, be careful to avoid steam burn. some cleaners can produce noxious fumes if applied to a hot surface.
- Do not place metallic objects such as knives, forks, spoons, and lids on the cooktop surface since they can get h

# INSTALLATION INSTRUCTIONS

This appliance shall only be installed by an authorized person. This appliance shall be installed in accordance with the manufactures installation instructions, IMPORTANT: this appliance must be installed in accordance with the norms in force of the country concerned.

The installation of this appliance must conform to local codes and ordinances.

The appliance , when installed, must be electrically grounded in accordance with local codes or, in absence of local codes, with the National Electrical Code, ANSI/NFPA 70, CSA C22.1-02

The correct voltage, frequency and amperage must be supplied to the appliance from a dedicated, grounded circuit which is protected by a properly sized circuit breaker or time delay fuse. The proper voltage, frequency and amperage ratings are listed on the product rating plate.

WARNING: Do not use aerosol sprays in the vicinity of this appliance while it is in operation. of turning on or shutting off gas to the appliance.

WARNING: Do not use aerosol sprays in the vicinity of this appliance while it is in operation.

The appliances should not be installed with a ventilation system that blows air downward toward the range.

A ventilation hood is recommended (but not required) for use with the gas cooktop.

Warning! Before removing the appliance disconnect the electric power supply cable and close the relevant shut off valve. Make sure that the electric power supply cable is not damaged during cleaning / maintenance operation.

# ELECTRICAL CONNECTION

The connection of the electrical supply must be done by approved installation contractors in accordance with specific National and Local installation standards in conformity with all safety regulations. The warning signs and rating plates on the appliances must strictly be followed. This unit is manufactured for a polarized, grounded 240 volt 60Hz (2 phases 6 AWG, 1 ground 8 AWG with plug, see Fig. A). Check and ensure that the supply voltage and the line current matches the specifications given on the rating plate. Before connecting the appliance to the electric network, follow the instructions below:

fuse and electric feeding installation of your home must support the load of the appliance (see registration label);

power supply system must be properly grounded;

the outlet or multiple-switch, with 1<sup>3</sup>/<sub>8</sub> inch diameter connection opening, has to be easily reached once the appliance has been installed;

the power supply cable should not reach a 120°F temperature.



**WARNING:** If the voltage is wrong, the hob can be damaged.

**WARNING:** Dangerous electric voltage inside! DO NOT OPEN induction unit.

# INSTRUCTIONS FOR USE

## Cooktop

### Before the first use

Clean your hob with a damp cloth, and then dry the surface thoroughly. Do not use detergent which risks causing bluetinted colour on the glass surface.

### INDUCTION PRINCIPLE

An induction coil is located under each heating zone. When it is engaged, it produces a variable electromagnetic field which produces inductive currents in the ferromagnetic bottom plate of the pan. The result is a heating-up of the pan located on the heating zone.

Of course the pan has to be suitable:

- All ferromagnetic pans are recommended (please verify it thanks a little magnet): cast iron and steel pans, enamelled pans, stainless-steel pans with ferromagnetic bottoms...
- Are excluded : copper, pure stainless-steel, aluminium, glass, wood, ceramic, stoneware,...

The induction heating zone adapts automatically the size of the pan. With a too small diameter the pans doesn't work. This diameter is varying in function of the heating zone diameter. If the pan is not suitable to the induction hob the display will show [U].

Magnetic material

Induction

Electromagnetic coil

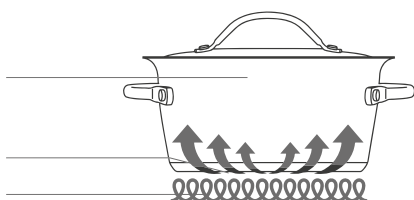

### IMPORTANT

The ceramic hob remains hot for a long time after use. Do not touch the hob with your hands or let children near it. The residual heat indicator will remain lit until the hob has cooled down.

If any cracks appear in the ceramic hob, disconnect the appliance immediately from the mains and call an authorized technical service centre.

The hob has cooking areas with different power values and diameters. The positions are clearly indicated by the rings

during operation, heat is located exclusively within these rings and the remaining area stays cold. Each

cooking area is designed to operate with specific pans for induction cooking, having a diameter just smaller than the diameter of the chosen cooking area. The bottom of the pan must be thick and flat. Its diameter must be as similar as possible to that of the cooking ring. The surface of the hob and the bottom of the pan must be kept clean.

Do not wet or overheat the plates.

Avoid sudden changes of temperature on the ceramic hob. For example, do not pour cold water onto the hot hob.

- Do not leave the pan handles sticking out as they could be flipped accidentally.
- It is preferable not to cook on the ceramic hob with pans that have been used on gas burners. The flames will have deformed the bottom of the pans.

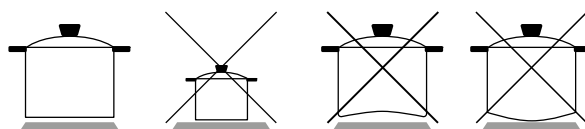

### WARNING

The glass ceramic cooking zone is warmed up from the heat of the pan. To avoid injuries (burning) do not touch this area.

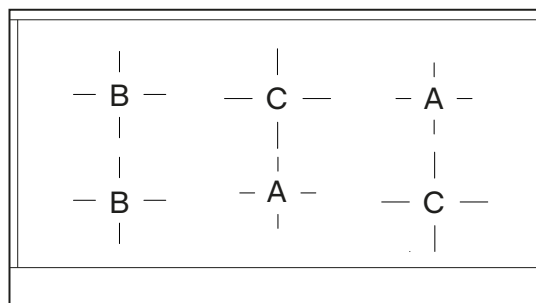

Burners	Cooking area (inch)	Electric power (watt)
A	ø 5"3/4	1400W / Booster 1800W
B	ø 7"1/4	1850W / Booster 2500W
C	ø 8"11/16	2300W / Booster 3200W

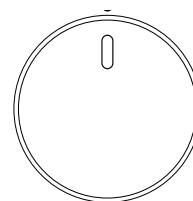

### Switching on a cooking area

A cooking area is switched on by pushing and turning the relevant knob (fig. 13) clockwise. The set power level appears on the hob display (from 1 to 9).

### Switching off a cooking area

A cooking area is switched off by turning the relevant knob anticlockwise. The symbol [0] appears on the hob display for 3 seconds, then it disappears from the display changes to the symbol [H], if the cooking area is still hot.

### Automatic switching off of the device

The device switches off automatically if any conditions of excess temperature (185°F) or errors in power supply occur.

# INSTRUCTIONS FOR USE

## BRIDGE function for the induction hob:

Place the pan in the middle of the two heating zones that will be connected (the two equal-sized zones).

Turn the knobs of the two affected zones clockwise and until the end of the stroke.

Hold them for 3 seconds to activate the function.

Adjust the power of the bridge with the front left area knob.

## BOOSTER function

The purpose of the booster function is to give more power to a determined area in order to reduce the necessary cooking time.

This function is activated by pushing and turning the knob clockwise from position 0 (off) to the final position. The symbol [P] appears on the display, meaning that the booster function is activated.

The Booster function has a maximum duration of 10 minutes. The area concerned then returns to level [9].

The Booster function ends before this time when:

- a lower power level is set
- the pan is removed
- there is overheating of the appliance or of the heating area

The Booster function has precedence over the "Heat-up" function. This means that, if the heat-up function has been activated in an area at the time of activating the Booster function, the heat-up function will be interrupted.

## Recognizing the presence of a pan

Each cooking area is designed to operate with specific pans for induction cooking, having a diameter just smaller than the diameter of the chosen cooking area. If the pan is not suitable, the display for the area shows the symbol indicating absence of the pan (U) and the appliance does not start up. This prevents the appliance being switched on until a container is placed on the cooking area, or until a container suitable for induction is used. If the container used on the cooking area is removed during this time, the area is switched off.

## Residual heat indication

If the cooking area is still very hot, even though it is switched off, the symbol H appears on the display.

## "HEAT-UP" FUNCTION

The Heat-up function, or quick heating, is available on each cooking area. This means that for a well defined time the cooking area works at maximum power and at the end of this time the power is automatically brought to the set level. In this case the duration depends on the set power level. The Heat-up function is activated by pushing and turning the knob anticlockwise from position 0 to the final position. As soon as the control is turned to the left, a letter [A] is shown on the display for the area. After it has been activated you must set a

power level to continue cooking within 3 to 5 seconds; if this is not done, the Heat-up function is interrupted.

## KEY-LOCK FUNCTION

The Key-lock function is useful if there are children at home. However, it is always advisable for an adult to be present

when the appliance is in operation. When the Key-lock function is activated all the cooking areas are switched off and they cannot be switched on accidentally.

The Key-lock function is activated, with the knobs in position 0, by turning the controls 1 and 2 simultaneously in an counterclockwise direction.

## Heating function 108°F AND 149°F

Turn the knob (A) clockwise. Between the off position (0) and the power position (1) there is the position (u) which identifies the function for heating food at 108°F. Only for 5 and 6-zone models: turn the knob (A) clockwise again.

Between the (u) position and the power position (1) there is the position (U) which identifies the function for heating food at 149°F. The maximum time of use for both functions is limited to 120 minutes. Both functions are prioritized over the 'HEAT-UP' mode.

The Key-lock function is activated, with the knobs in position 0, by turning the controls 2 and 3 in a counterclockwise

direction. The letters [L][L][L][L] appear on the display. The Key-lock function is deactivated by repeating the same

operation. The letters [O][F] appear on the display. If a knob is turned when the key-lock function is active, the letters [L][L][L][L] appear on the disp.

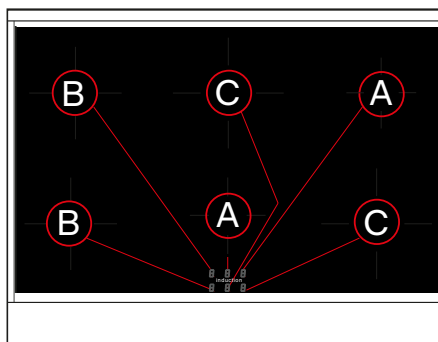

## DISPLAY: A display is associated with each cooking area

Set power level	(1-9)
Food heating 108°F 149°F	(U)
Booster	(P)
Heat-up	(A)
Residual heat	(H)
Pan absent or not suitable	(U)
External error	(E)
Fault	(F)
Key-lock function	[L][L][L][L]
Knob permanent rotation	└┘

# INSTRUCTIONS FOR USE

## Residual heat indication

A maximum time of continuous operation is associated with each cooking area.

This depends on the set power level. If the limit of the duration of operation is reached, the respective area is switched off

## OPERATING TABLE (purely indicative values)

Knob position	Type of cooking
1-2	melting butter, chocolate, etc.
2-4	heating small amounts of liquids, keeping food warm, preparing sauces.
4-5	heating solid foods, thawing frozen foods, omelettes with 2-3 eggs, fruit and vegetables.
5-6	cooking meat and fish, pulses in sauces, dishes with water, making jam.
6-7	roasting meat or fish, steaks, liver, eggs.
8-9	boiling large amounts of water, frying chips, etc.

## Time limit operation table

Power Level	Approximate limit of the duration of operation (hours)
U	2
1	6
2	6
3	5
4	5
5	4
6	1,5
7	1,5
8	1,5
9	1,5
P	(10 min. [P], later 80 min. [9])

# CLEANING AND MAINTENANCE

## List with common types of soiling and recommendations how to treat them:

Type of soiling	Treatment
Slight soiling, no burned residues	Wipe with a moist cloth (scotch), without cleaning agent
Sticky soiling	Remove with a scraper. Then wipe the heating area with a moist cloth
Lime deposits, caused by water which has boiled over	These spots can be removed with vinegar or a special cleaning agent
Sugar, sugar containing food, plastic, aluminum foil	Immediately scrape off the sugar, plastic or aluminum foil residues thoroughly from the hot cooking area, e.g. with a razor blade. After removal of the residues, clean it with a cleaning agent. If the heating area is soiled with residues of sugar, plastic or aluminum foil cools down without prior cleaning, the ceramic surface might become deformed by pinheadsized pits.

The cleaning of the Ceran glass is identical to other similar surfaces like glass. Do not use corrosive or abrasive cleaning agents, such as grill and oven-sprays, stain- and rust-removers, scouring powder and rough sponges.

Before being cleaned, the Ceran glass must be cooled down.

Other maintenance and servicing work other than cleaning as described here, must be done by authorized service personnel.

Make sure that no liquid can enter in the induction unit.

## WARNING

**Do not open the induction unit, dangerous electric voltage inside. The hobs may only be opened by authorized personnel.**



# PROXIMITY TO SIDE CABINET INSTALLATION

The cooktop may be installed directly to existing base cabinets. The cooktop CANNOT be installed directly adjacent to sidewalls, tall cabinets, tall appliances, or other side vertical surfaces above 36" (91.4 cm) high. There must be a minimum of 8" (20.3 cm) side clearance from the cooktop to such combustible surfaces above the 36" (91.4 cm) counter height.

Within the 8" (20.3 cm) side clearance to combustible vertical surfaces above 36" (91.4 cm), the maximum wall cabinet depth must be 13" (33.0 cm) and wall cabinets within this 8" (20.3 cm) side clearance must be 18" (45.7 cm) above the 36" (91.4 cm) high countertop.

The maximum wall cabinet depth must be 13" (33.0 cm) and wall cabinets within this 8" (20.3 cm) side clearance must be 18" (45.7 cm) above the 36" (91.4 cm) high countertop

Wall cabinet above the cooktop must be a minimum of 36" (91.4 cm) above the burner grates. This minimum height requirement does not apply if a rangehood is installed over the cooking surface.

## Minimum Clearances from Adjacent

### Combustible Construction

Above countertop 36" (91.4 cm) minimum

Side 8" (20.3 cm)

Wall cabinets no deeper than 13" (33.0 cm)

Must be minimum 18" (45.7 cm) above countertop

Wall cabinets directly above the product must be minimum 36" (91.4 cm) above the burner grates

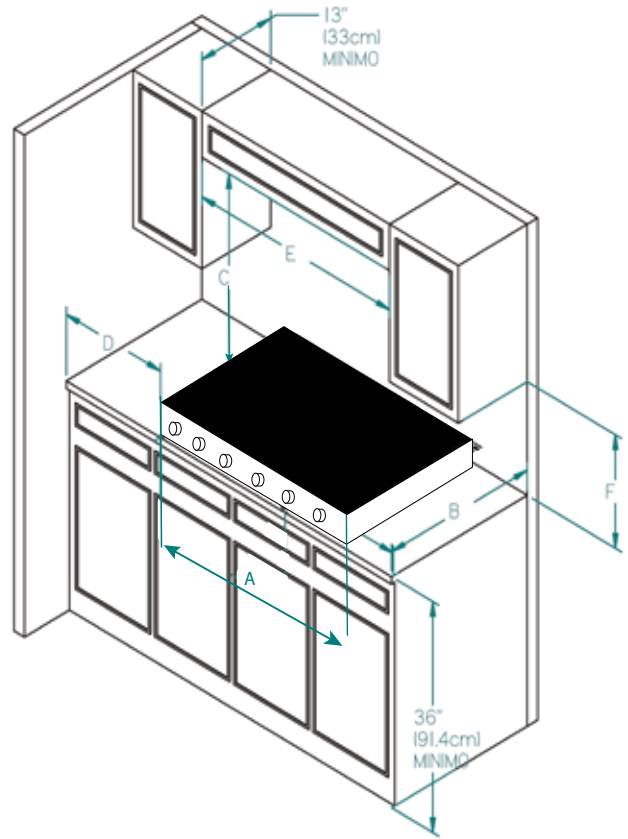

	<b>UHCPI366 UHCPI366N</b>	<b>UHCPI486 UHCPI486N</b>
A	35 7/8' (91.1 cm)	47 7/8' (121.6 cm)
B	25 19/32' (65 cm)	25 19/32' (65 cm)
C	MIN. 36' (91.4 cm)	MIN. 36' (91.4 cm)
D	MIN. 8' (20.3 cm)	MIN. 8' (20.3 cm)
E	MIN. 36' (91.4 cm)	MIN. 48' (121.9 cm)
F	MIN. 18' (47.7 cm)	MIN. 18' (47.7 cm)







Live,  
Cook,  
Love.

**ilve.com**

ILVE S.p.A Via Antoniana, 100 – 35011 – Campodarsego (PD) Italy  
T. +39 049 9200990 / Email: mail@ilve.com

cod. EI33960770000EN 06/2025